

»» Features

- High rating miniature PCB Relay.
- AC & DC coil are both available.
- UL/CUL and VDE approved.
- 17A 277VAC SPDT.
- Low profile 15.7mm and high insulation system Class F.
- High CTI 250 material or product comply with IEC 60335-1 are available.
- Special version for inrush rating application is available. (888-IR type)
- Complies with RoHS-Directive 2011/65/EU.
- Optional for halogen free version.
- Optional for explosion-proof version.

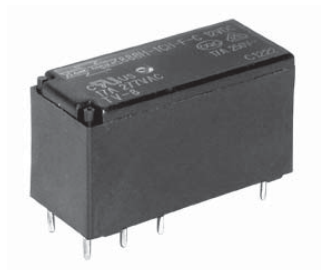

»» Type List

◆ Standard Type

Terminal style	Contact form	UL Insulation system approval	Designation (provided with)		
			Flux tight	Sealed type	Sealed type washable
PCB terminal	1A (SPNO)	F	888-1AC-F-C	888-1AC-F-V	888-1AC-F-S
			888-1AH-F-C	888-1AH-F-V	888-1AH-F-S
	1C (SPDT)	F	888-1CC-F-C	888-1CC-F-V	888-1CC-F-S
			888-1CH-F-C	888-1CH-F-V	888-1CH-F-S
	2A (DPNO)	F	888-2AC-F-C	888-2AC-F-V	888-2AC-F-S
			888-2AH-F-C	888-2AH-F-V	888-2AH-F-S
	2C (DPDT)	F	888-2CC-F-C	888-2CC-F-V	888-2CC-F-S
			888-2CH-F-C	888-2CH-F-V	888-2CH-F-S

◆ High Sensitivity Type (N) / Ultra-Sensitivity Type (N1)

PCB terminal	1A (SPNO)	F	888N-1AC-F-C	888N-1AC-F-V	888N-1AC-F-S
			888N1-1AC-F-C	888N1-1AC-F-V	888N1-1AC-F-S
			888N-1AH-F-C	888N-1AH-F-V	888N-1AH-F-S
			888N1-1AH-F-C	888N1-1AH-F-V	888N1-1AH-F-S
	1C (SPDT)	F	888N-1CC-F-C	888N-1CC-F-V	888N-1CC-F-S
			888N1-1CC-F-C	888N1-1CC-F-V	888N1-1CC-F-S
			888N-1CH-F-C	888N-1CH-F-V	888N-1CH-F-S
	2A (DPNO)	F	888N-2AC-F-C	888N-2AC-F-V	888N-2AC-F-S
			888N-2AH-F-C	888N-2AH-F-V	888N-2AH-F-S
	2C (DPDT)	F	888N-2CC-F-C	888N-2CC-F-V	888N-2CC-F-S
888N-2CH-F-C			888N-2CH-F-V	888N-2CH-F-S	

◆ High Power Type

PCB terminal	1A (SPNO)	F	888H-1AC-F-C	888H-1AC-F-V	888H-1AC-F-S
			888H-1AH-F-C	888H-1AH-F-V	888H-1AH-F-S
	1C (SPDT)	F	888H-1CC-F-C	888H-1CC-F-V	888H-1CC-F-S
			888H-1CH-F-C	888H-1CH-F-V	888H-1CH-F-S

◆ High Power Type · High Sensitivity Type

PCB terminal	1A (SPNO)	F	888HN-1AC-F-C	888HN-1AC-F-V	888HN-1AC-F-S
			888HN-1AH-F-C	888HN-1AH-F-V	888HN-1AH-F-S
	1C (SPDT)	F	888HN-1CC-F-C	888HN-1CC-F-V	888HN-1CC-F-S
			888HN-1CH-F-C	888HN-1CH-F-V	888HN-1CH-F-S

Note : 888A—Special footprint 5.0mm pinning version can be selected.

◆ Inrush Type (only for 0.53W)

PCB terminal	1A (SPNO)	F	888H-1AH-F-C IR	888H-1AH-F-V IR	888H-1AH-F-S IR
	1C (SPDT)		888H-1CH-F-C IR	888H-1CH-F-V IR	888H-1CH-F-S IR

»» Ordering Information

888 - 1C C - - C
 1 2 3 4 5 6 7 8 9

- | | | | |
|----------|--|-----------------------------|--|
| 1. 888 | -- Basic series designation | 2C | -- Double pole double throw |
| 2. Blank | -- Standard type
(1P - Terminal pitch 3.5mm)
(2P - Terminal pitch 5.0mm) | 5. C | -- Contact material AgNi |
| A | -- Standard type and special terminal pitch
(1P - Terminal pitch 5.0mm) | H | -- Contact material AgSnO |
| H | -- High power type (only for 1P type) | 6. Blank | -- Standard type |
| 3. Blank | -- Standard type
(DC: 0.53 W) (AC: 0.75 VA) | F | -- Class F |
| N | -- High sensitivity type (0.40 W) | 7. C | -- Flux tight |
| N1 | -- Ultra-sensitivity type (0.25 W)
(only for 1P type) | V | -- Sealed type |
| 4. 1A | -- Single pole normally open | S | -- Sealed type washable |
| 1B | -- Single pole normally closed | 8. Blank | -- Standard type |
| 1C | -- Single pole double throw | E1 | -- Comply with IEC 60335-1 |
| 2A | -- Double pole normally open | IR | -- 888 Inrush type (only for H ·
1A/1C type) |
| 2B | -- Double pole normally closed | 9. <input type="checkbox"/> | -- Coil voltage (please refer to the
coil rating data for the availability) |

»» Contact Rating

Type	1P			2P
	888 · 888N	888N1	888H · 888HN	888 · 888N
Rated load (resistive)	12A 240VAC	10A 240VAC	16A 240VAC	8A 240VAC
Max. switching current	12A	10A	17A	8A
Max. switching voltage	277VAC	277VAC	277VAC	277VAC
Max. switching capacity	2880VA	2400VA	4080VA	1920VA

◆ Inrush type

Tungsten Lamp	NO: 1500W 240VAC (Inrush 110A), 30K ops.
Halogen Lamp	NO: 1500W 240VAC (Inrush 110A), 30K ops.

»» Coil Rating (DC)

◆ Standard Type

Rated voltage (V)	Rated current $\pm 10\%$ at 23°C (mA)	Coil resistance $\pm 10\%$ at 23°C (Ω)	Max. continuous voltage at 85°C	Pick up voltage(Max.) at 23°C	Drop out voltage(Min.) at 23°C	Power consumption at rated voltage
3	176	17	150 % of rated voltage	75 % of rated voltage	10 % of rated voltage	approx. 0.53W
5	106	47				
6	88	68				
9	59	153				
12	44	272				
15	35	425				
18	29	611				
24	22	1,087				
36	15	2,445				
48	11	4,347				

◆ High Sensitivity Type (N)

Rated voltage (V)	Rated current $\pm 10\%$ at 23°C (mA)	Coil resistance $\pm 10\%$ at 23°C (Ω)	Max. continuous voltage at 85°C	Pick up voltage(Max.) at 23°C	Drop out voltage(Min.) at 23°C	Power consumption at rated voltage
3	133	22.5	150 % of rated voltage	70 % of rated voltage	10 % of rated voltage	approx. 0.40W
5	80	62				
6	67	90				
9	44	203				
12	33	360				
18	23	771				
24	17	1,440				
36	11	3,240				
48	9	5,520				

◆ Ultra-Sensitivity Type (N1)

Rated voltage (V)	Rated current $\pm 10\%$ at 23°C (mA)	Coil resistance $\pm 10\%$ at 23°C (Ω)	Max. continuous voltage at 85°C	Pick up voltage(Max.) at 23°C	Drop out voltage(Min.) at 23°C	Power consumption at rated voltage
3	83	36	150 % of rated voltage	75 % of rated voltage	10 % of rated voltage	approx. 0.25W
5	50	100				
6	42	144				
9	28	324				
12	21	576				
18	14	1,296				
24	10	2,304				
36	7	5,184				

»» Coil Rating (AC)

Rated voltage (V)	Rated current ±10% at 23°C (mA)	Coil resistance ±10% at 23°C (Ω)	Max. continuous voltage at 70°C	Pick up voltage(Max.) at 23°C	Drop out voltage(Min.) at 23°C	Power consumption at rated voltage
6	124	18.8	110 % of rated voltage	80 % of rated voltage	15 % of rated voltage	approx. 0.75VA
12	62.5	79.8				
24	31.2	334				
42	17.9	966				
48	15.5	1,340				
100/110	7.53	6,840				
110/120	6.8	7,360				
200/220	3.75	23,800				
220/240	3.4	27,400				

»» Specification

Contact material	AgNi / AgSnO alloy	
Contact resistance ⁽¹⁾	100mΩ Max. (at 1A/6VDC by 4-wire resistance measurement)	
Operate time ⁽¹⁾	20ms Max.	
Release time ⁽¹⁾	10ms Max.	
Vibration resistance	Operating extremes	10 ~ 55Hz , amplitude 1.5 mm
	Damage limits	10 ~ 55Hz , amplitude 1.5 mm
Shock resistance	Operating extremes	10G
	Damage limits	100G
Life expectancy	Mechanical	30,000,000 ops. (frequency 72,000 ops./hr) 5,000,000 ops. (for 2P AC type) (frequency 18,000 ops./hr)
	Electrical	100,000 ops. (frequency 360 ops./hr)
Operating ambient temperature	DC coil	-40 ~ +85°C (no freezing) ⁽²⁾
	AC coil	-40 ~ +70°C (no freezing)
Weight	Approx. 10 g	

Note : (1) Initial value. Operate and release time excluding contact bounce.

(2) Special version of high temperature 105°C can be selected.

(3) Unless otherwise specified, all tests are under room temperature and humidity.

(4) Consider the heat of PCB is necessary, please check the actual condition of PCB.

(5) Applying no diode to this relay. The life expectancy will be lower when a diode is used. To use a varistor (ZNR) could absorb the coil surge of relay that is recommended.

- (6) Do not use the relay exceeding the coil rating, contact rating and life expectancy, or this may cause the risk of overheating.
- (7) To assure optimum performance, avoid the relay from dropping, hitting, or other unnecessary shocks.
- (8) Do not switch the contacts without any load as the contact resistance may become increased rapidly.
- (9) Flux tight version is recommended. If there is cleaning process and sealed type is selected, the vent-hole should be removed after the process.
- (10) Usage, transport and storage conditions
- 1. Temperature: -40~+85°C
 - 2. Humidity: 5 to 85% R.H.
 - 3. Pressure: 86 to 106 kPa
 - Furthermore, the humidity range varies with the temperature. So, use relays within the range indicated in the graph below.

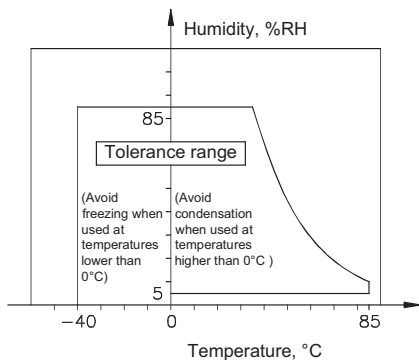

(11) Please contact Song Chuan for the detailed information.

»» Insulation Data

Insulation resistance ⁽¹⁾	1000MΩ Min. (DC 500V)
Surge voltage withstand ⁽¹⁾	Between contact and coil : 10KV (1.2X50) μ S
Dielectric strength ⁽¹⁾	Between open contact : AC 1000V, 50/60Hz 1 min.
	Between contact and coil : AC 5000V, 50/60Hz 1 min.
	Between contact circuits : AC 3000V, 50/60Hz 1 min. (for 2P DC type) AC 2500V, 50/60Hz 1 min. (for 2P AC type)
Insulation of IEC 61810-1	
Clearance / creepage distances	Between coil to contact : Reinforce, ≥ 6.0mm / ≥ 8.0mm
	Between open contact : Functional
Rated insulation voltage	250V
Rated impulse withstand voltage	4000V
Pollution degree	3
Rated voltage	230 / 400V
Overvoltage category	II

Note : (1) Initial value.

»» Safety Approval

Certified	UL / CUL	VDE
File No.	E88991	40006746

»» Safety Approval Rating (VDE)

◆ DC coil

888H · 888HN	888 · 888N · 888N1	888 · 888N
	1P	2P
17A 250VAC T105	12A 250VAC T105	12A 250VAC T85 10A 250VAC T105

◆ AC coil

888H	888
17A 250VAC T85	1P: 12A 250VAC T85 2P: 10A 250VAC T85

»» Safety Approval Rating (UL/CUL)

888 (1P)		888 (2P)	888N1
C · CA	H · HA		
NO/NC: 17A 277VAC NO: 12A 30VDC 1HP 480VAC NC: 1/2HP 120/240/480VAC	NO/NC: 17A 277VAC 1HP 120/240/480VAC NO: TV-8 NC: 12A 30VDC 1/2HP 120/240/480VAC	NO/NC: 12A 277VAC NO: 1/2HP 120/240VAC TV-5 (H · HA type only) NC: 1/3HP 120/240VAC	17A 277VAC 12A 30VDC

»» Outline Dimensions

◆ 888 1P

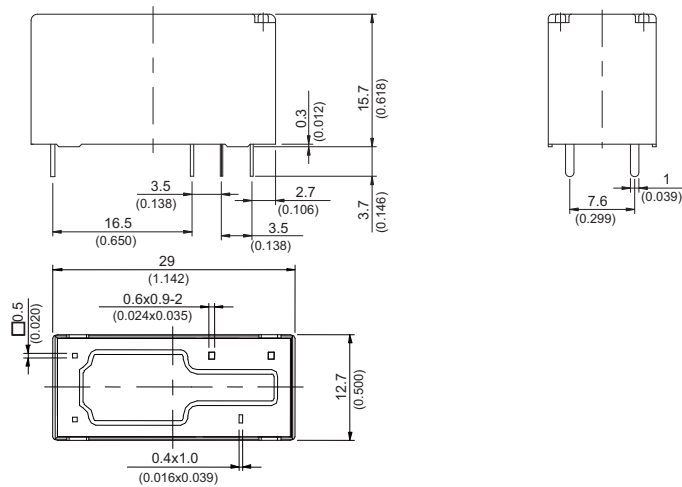

◆ 888H 1P

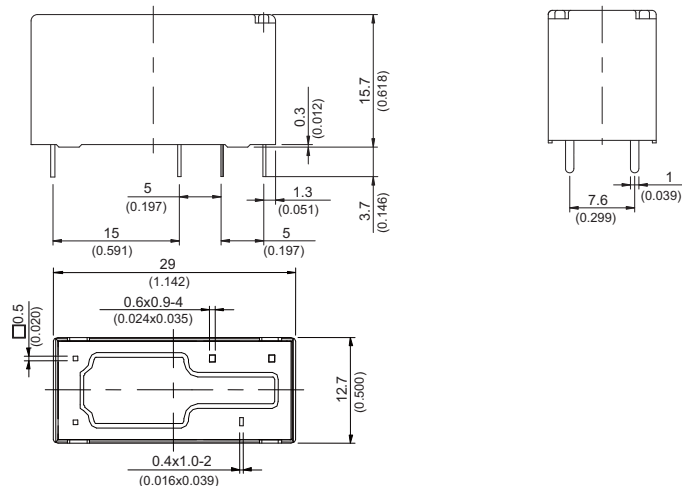

◆ 888 2P

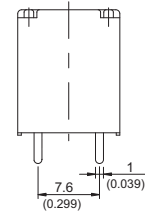
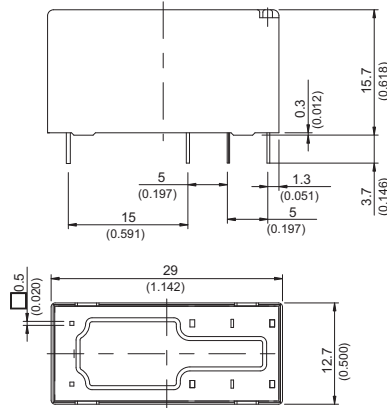

TOLERANCE:
 LESS THAN: 1(0.039) ±0.1(0.004)
 5(0.197) ±0.3(0.012)
 20(0.787) ±0.5(0.020)
 MORE THAN: 20(0.787) ±1(0.039)

»» Wiring Diagram
 BOTTOM VIEW

◆ 888

1C

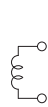

1A

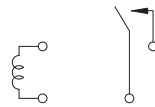

2C

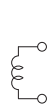

2A

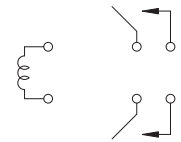

◆ 888H

1C

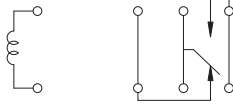

1A



»» PC Board Layout
 BOTTOM VIEW

◆ 888

1C

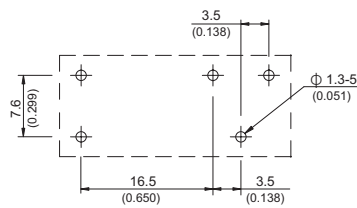

1A

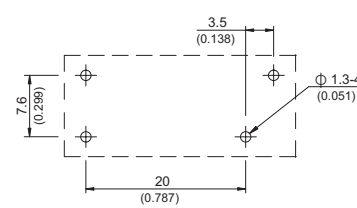

2C

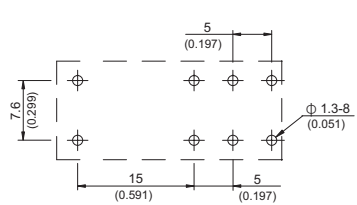

2A

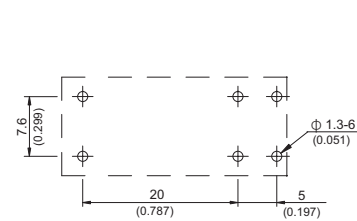

◆ 888H

1C

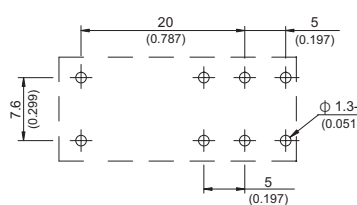

1A

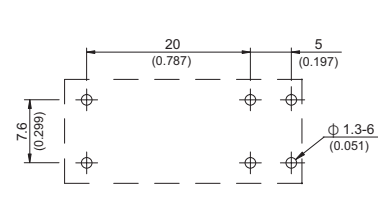

»» Engineering Data

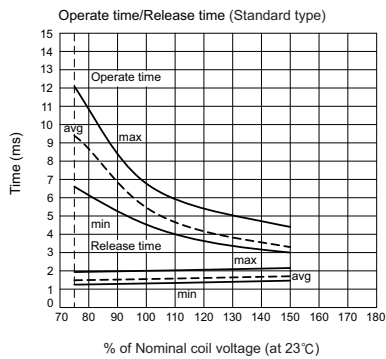
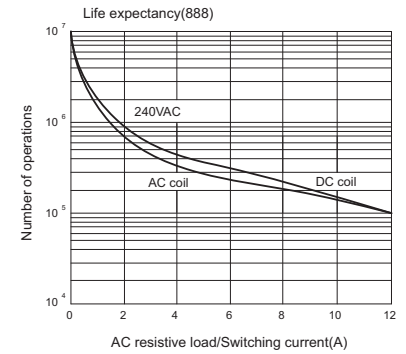
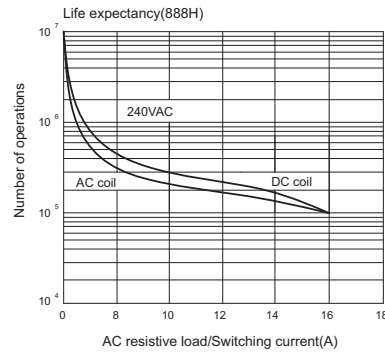
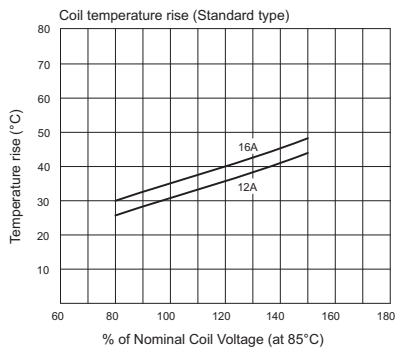
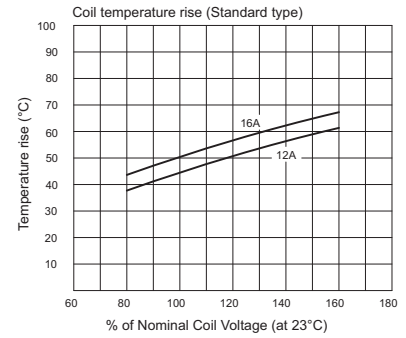
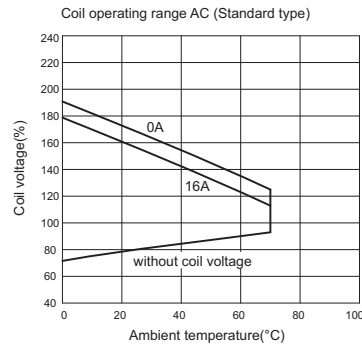
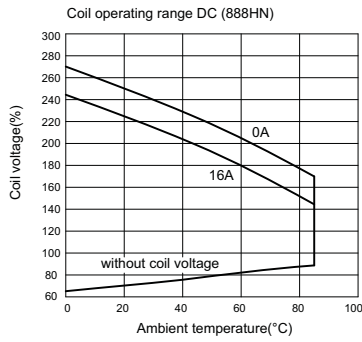

◆ 888 / 888H

