

**1 Scope:**

- 1.1 This specification is applicable to lead free and halogen free for LRH series low-inductance metal alloy low-resistance resistor.
- 1.2 The product is belong to the universal series.

**2 Explanation Of Part Numbers:**

<u>LRH</u>	<u>2512</u>	-	<u>2</u>	<u>2</u>	<u>R003</u>	<u>F</u>	<u>5</u>
<b>Type</b>	<b>Size (inch)</b>	<b>Number of Terminals</b>	<b>Rated Power</b>	<b>Resistance (4~6 Digits)</b>	<b>Tolerance</b>	<b>Packaging</b>	
Low-Inductance Metal Alloy Low Resistance Resistor	0402 0603 0805 1206 2512	2: 2 terminals	H=0.20W F=0.33W C=0.50W A=1.50W 1=1.00W 2=2.00W 3=3.00W	EX: R003 = 3mΩ R0015 = 1.50mΩ R0005 = 0.50mΩ R00075= 0.75mΩ	D=±0.5% F=±1.0% G=±2.0% J=±5.0%	4=4,000pcs 5=5,000pcs 10=10,000pcs	

**3 Product Specifications:**

Type	# of Terminals	Max. Rating Power	(Ir) Rating Current	(Io) Overload Current	T.C.R. (ppm/°C)	Inductance	Resistance Range (mΩ)			Operating Temperature Range									
							D (±0.5%)	F (±1%) G (±2%) J (±5%)											
0402	2	0.20W	$I_r = \sqrt{P/R}$ <small>Ir: Rating Current (A) P: Rating Power(W) R: R value(Ω)</small>	$I_o = \sqrt{NP/R}$ <small>Io: Overload Current (A) P: Rating Power(W) R: R value(Ω) N: LRH2512 : 5 Others : 4</small>	≤ ±800	< 5nH	--	1.5	-55~+150°C										
							--	3 ≤ R ≤ 4											
							--	5											
							--	10											
0603	2	0.33W					$I_r = \sqrt{P/R}$ <small>Ir: Rating Current (A) P: Rating Power(W) R: R value(Ω)</small>	$I_o = \sqrt{NP/R}$ <small>Io: Overload Current (A) P: Rating Power(W) R: R value(Ω) N: LRH2512 : 5 Others : 4</small>		≤ ±200	< 5nH	--	1 ≤ R < 4	-55~+150°C					
												--	4 ≤ R < 8						
												--	8 ≤ R ≤ 24						
												--	1 ≤ R < 2						
0805	2	0.5W										$I_r = \sqrt{P/R}$ <small>Ir: Rating Current (A) P: Rating Power(W) R: R value(Ω)</small>	$I_o = \sqrt{NP/R}$ <small>Io: Overload Current (A) P: Rating Power(W) R: R value(Ω) N: LRH2512 : 5 Others : 4</small>		≤ ±125	< 5nH	--	2 ≤ R < 3	-55~+150°C
																	--	3 ≤ R < 5	
																	--	5 ≤ R ≤ 19	
																	--	1 ≤ R < 2	
1206	2	0.5W	$I_r = \sqrt{P/R}$ <small>Ir: Rating Current (A) P: Rating Power(W) R: R value(Ω)</small>	$I_o = \sqrt{NP/R}$ <small>Io: Overload Current (A) P: Rating Power(W) R: R value(Ω) N: LRH2512 : 5 Others : 4</small>	≤ ±50	< 5nH			--								2 ≤ R < 4	-55~+150°C	
									--								4 ≤ R ≤ 21		
		1.0W							--								1 ≤ R < 2		
									--								2 ≤ R < 4		
2512	2	1.5W					$I_r = \sqrt{P/R}$ <small>Ir: Rating Current (A) P: Rating Power(W) R: R value(Ω)</small>	$I_o = \sqrt{NP/R}$ <small>Io: Overload Current (A) P: Rating Power(W) R: R value(Ω) N: LRH2512 : 5 Others : 4</small>	≤ ±400	< 5nH	--			4 ≤ R ≤ 10			-55~+170°C		
		2.0W									7~50			3~100					
		3.0W									7~50			3~70					
											$I_r = \sqrt{P/R}$ <small>Ir: Rating Current (A) P: Rating Power(W) R: R value(Ω)</small>			$I_o = \sqrt{NP/R}$ <small>Io: Overload Current (A) P: Rating Power(W) R: R value(Ω) N: LRH2512 : 5 Others : 4</small>			≤ ±50		

<b>IE</b>			<b>QA</b>		<b>Remark</b>	Issue Dep. <b>DATA Center.</b>
Written	Checked	Approved	Signing	IT'S NOT UNDER CONTROL FOR PDF FILE PLS NOTE THE VERSION STATED..		
					Series No. <b>60</b>	

**3.1 Power Derating Curve:**

Type	0402/0603/0805/1206	2512
Operating Temperature Range	-55°C ~ +150°C	-55°C ~ +170°C
Explain	For resistors operated in ambient temperatures above 70°C, power rating shall be derated in accordance with figure below.	For resistors operated in ambient temperatures above 70°C, power rating shall be derated in accordance with figure below.
Figure		

**Remark**

IT'S NOT UNDER CONTROL FOR PDF FILE  
PLS NOTE THE VERSION STATED..

Issue Dep.**DATA Center.**

Do not copy without permission

Series No. **60**

**4 Physical Dimensions:**

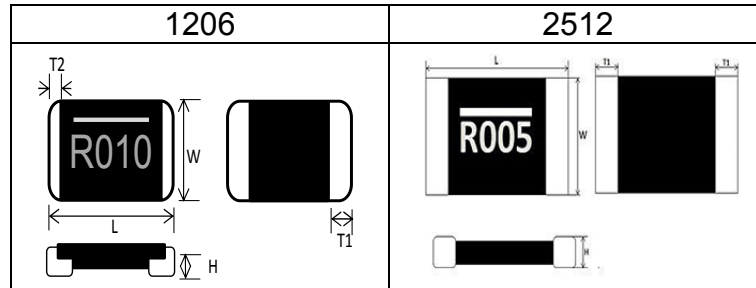
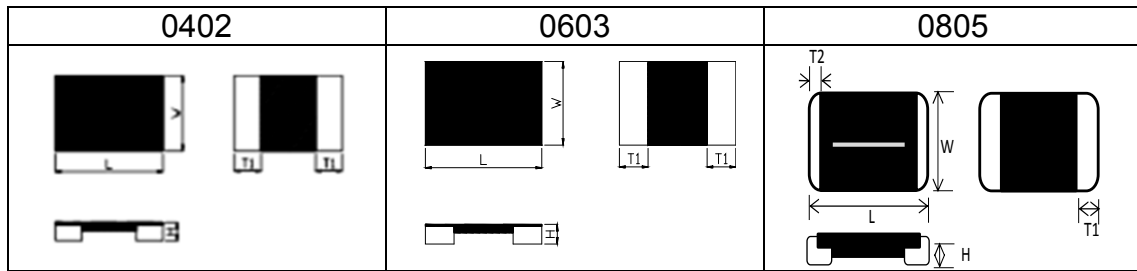

Type	Power Rating (Watts)	Resistance Range (mΩ)	Dimensions - in inches (millimeters)				
			L	W	H	T1	T2
0402	0.20W	1.5 3~5 10	0.039±0.004 (1.00±0.100)	0.020±0.004 (0.50±0.100)	0.014±0.004 (0.35±0.10)	0.010±0.004 (0.25±0.100)	
0603	0.33W	1~24	0.063±0.008 (1.60±0.20)	0.031±0.008 (0.80±0.20)	0.014±0.004 (0.35±0.10)	0.012±0.006 (0.30±0.15)	
0805	0.50W	1	0.08±0.008 (2.0320±0.20)	0.05±0.008 (1.270±0.20)	0.014±0.004 (0.35±0.10)	0.023±0.006 (0.60±0.15)	0.008±0.006 (0.20±0.15)
		2			0.014±0.004 (0.35±0.10)	0.02±0.006 (0.50±0.15)	0.008±0.006 (0.20±0.15)
		3~19			0.014±0.004 (0.35±0.10)	0.014±0.008 (0.35±0.20)	0.008±0.006 (0.20±0.15)
1206	0.5 1	1 ≤ R < 3	0.126±0.008 (3.20±0.20)	0.063±0.008 (1.60±0.20)	0.016±0.008 (0.40±0.20)	0.035±0.008 (0.90±0.20)	0.008±0.006 (0.20±0.15)
		3 ≤ R < 4				0.024±0.008 (0.60±0.20)	0.008±0.006 (0.20±0.15)
		4 ≤ R ≤ 21				0.014±0.008 (0.35±0.20)	0.008±0.006 (0.20±0.15)
2512	1.50W	3~70	0.246±0.010 (6.248±0.254)	0.126±0.010 (3.202±0.254)	0.0254±0.010 (0.645±0.254)	0.044±0.010 (1.118±0.254)	
		71~100				0.034±0.010 (0.868±0.254)	
	2.00W	3~70				0.044±0.010 (1.118±0.254)	
	3.00W	3~10					

Remark

IT'S NOT UNDER CONTROL FOR PDF FILE  
PLS NOTE THE VERSION STATED..

Issue Dep. DATA Center.

Do not copy without permission

Series No. **60**

**4.1 Material of Alloy**

Type	Material	Resistance
0402	Manganese-Copper Alloy	1.5mΩ / 3-4mΩ / 5mΩ / 10mΩ
0603	Manganese-Copper Alloy	1mΩ- 24mΩ
0805	Manganese-Copper Alloy	1mΩ- 19mΩ
1206	Manganese-Copper Alloy	1mΩ- 21mΩ
2512	Manganese-Copper Alloy	3mΩ- 5mΩ
	Nickel-Chromium- Aluminum Alloy	6mΩ- 100mΩ

**5 Reliability Performance:**

**5.1 Electrical Performance:**

Test Item	Conditions of Test	Test Limits																						
Temperature Coefficient of Resistance (TCR)	<ul style="list-style-type: none"> <li>TCR (ppm/°C) = <math>\frac{(R2-R1)}{R1 (T2-T1)} \times 10^6</math></li> <li>R1: resistance of room temperature</li> <li>R2: resistance of 150 °C</li> <li>T1: Room temperature</li> <li>T2: Temperature at 150 °C</li> <li>Refer to JIS C 5201-1 4.8</li> </ul>	Refer to Paragraph 3. general specifications																						
Short Time Overload	<p>Applied Overload for 5 seconds and release the load for about 30 minutes, then measure its resistance variance rate. (Overload condition refer to below):</p> <table border="1"> <thead> <tr> <th>Type</th> <th>Power (W)</th> <th># of rated power</th> </tr> </thead> <tbody> <tr> <td>0402</td> <td>0.2</td> <td>4 times</td> </tr> <tr> <td>0603</td> <td>0.33</td> <td>4 times</td> </tr> <tr> <td>0805</td> <td>0.5</td> <td>4 times</td> </tr> <tr> <td>1206</td> <td>0.5、1</td> <td>4 times</td> </tr> <tr> <td rowspan="3">2512</td> <td>1.5</td> <td>5 times</td> </tr> <tr> <td>2.0</td> <td>5 times</td> </tr> <tr> <td>3.0</td> <td>5 times</td> </tr> </tbody> </table> <p>Refer to JIS C 5201-1 4.13</p>	Type	Power (W)	# of rated power	0402	0.2	4 times	0603	0.33	4 times	0805	0.5	4 times	1206	0.5、1	4 times	2512	1.5	5 times	2.0	5 times	3.0	5 times	<p>0402、0805、1206 : <math>\leq \pm 0.5\%</math> 2512 : <math>\leq \pm 2\%</math></p>
Type	Power (W)	# of rated power																						
0402	0.2	4 times																						
0603	0.33	4 times																						
0805	0.5	4 times																						
1206	0.5、1	4 times																						
2512	1.5	5 times																						
	2.0	5 times																						
	3.0	5 times																						
Insulation Resistance	<p>Put the resistor in the fixture, add 100 VDC in +, - terminal for 60secs then measured the insulation resistance between electrodes and insulating enclosure or between electrodes and base material. Refer to JIS-C5201-1 4.6</p>	$\geq 10^8 \Omega$																						
Dielectric Withstanding Voltage	<p>Applied 300VAC for 1 minute, and Limit surge current 50 mA (max.) Refer to JIS-C5201-1 4.7</p>	No short or burned on the appearance.																						

Remark

IT'S NOT UNDER CONTROL FOR PDF FILE  
PLS NOTE THE VERSION STATED..

Issue Dep. **DATA Center.**

Do not copy without permission

Series No. **60**

**5.2 Mechanical /Constructional Performance:**

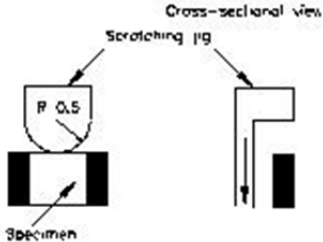
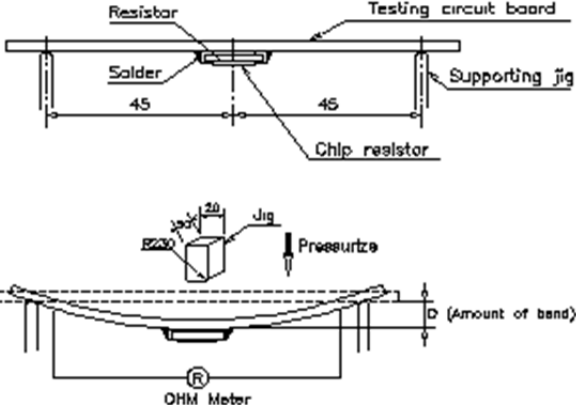
Test Item	Conditions of Test	Test Limits
<p>Joint Strength of Solder</p>	<p>Test method:                      ◎Test item 1 (Adhesion):                      A static load using a R0.1 scratch tool shall be applied on the core of the component and in the direction of the arrow and held for 10 seconds and under 20N load measured its resistance variance rate.</p>  <p>Refer to JIS-C5201-1 4.32                      ◎Test item 2 (Bending Strength):                      Solder tested resistor on to PC board add force in the middle down, and under load measured its resistance variance rate.                      2512, 1206, 0805, D=3mm, 0603 D=5mm</p>  <p>Refer to JIS-C5201-1 4.33</p>	<p>Test item 1:                      (1).Variance rate on resistance :  <math>\pm 1.0\%</math>                      (2).No evidence of mechanical damage.                      No terminal peeling off.</p> <p>Test item 2:                      (1).Variance rate on resistance :  <math>\pm 1.0\%</math>                      (2).No evidence of mechanical damage.                      No terminal peeling off and core body cracked.</p>
<p>Resistance to Solder Heat</p>	<p>The tested resistor be immersed 25 mm/sec into molten solder of <math>260\pm 5^{\circ}\text{C}</math> for <math>10\pm 1</math>secs. Then the resistor is left in the room for 1 hour, and measured its resistance variance rate.                      Refer to JIS-C5201-1 4.18</p>	<p><math>\leq \pm 0.5\%</math>                      No evidence of mechanical damage</p>
<p>Solderability</p>	<p>Add flux into tested resistors, immersion into solder bath in temperature <math>245\pm 5^{\circ}\text{C}</math> for <math>3\pm 0.5</math>secs.                      Refer to JIS-C5201-1 4.17</p>	<p>Solder coverage over 95%</p>
<p>Core Body Strength (1206 ((included)) above applies)</p>	<p>Applied R0.5 test probe at its central part then pushing 5N force on the sample for 10 sec.                      Refer to JIS-C5201-1 4.15</p>	<p><math>\leq \pm 0.5\%</math>                      No evidence of mechanical damage</p>

Remark

IT'S NOT UNDER CONTROL FOR PDF FILE  
 PLS NOTE THE VERSION STATED..

Do not copy without permission

Issue Dep.**DATA Center.**

Series No. **60**

Test Item	Conditions of Test	Test Limits
Vibration	The resistor shall be mounted by its terminal leads to the supporting terminals on the solid table. The entire frequency range :from 10 Hz to 55 Hz and return to 10 Hz, shall be transferred in 1 min. Amplitude : 1.5mm This motion shall be applied for a period of 4 hours in each 3 mutually perpendicular directions (a total of 12hrs) Refer to JIS-C5201-1 4.22	$\leq \pm 0.5\%$ No evidence of mechanical damage
Resistance to solvent	The tested resistor be immersed into isopropyl alcohol of 20~25°C for 60secs, then the resistor is left in the room for 48 hrs. Refer to JIS-C5201-1 4.29	$\leq \pm 0.5\%$ No evidence of mechanical damage

### 5.3 Environmental Performance:

Test Item	Conditions of Test	Test Limits						
Low Temperature Exposure (Storage)	Put the tested resistor in chamber under temperature $-55 \pm 2^\circ\text{C}$ for 1,000 hours. Then leaving the tested resistor in room temperature for 60 minutes, and measure its resistance variance rate. Refer to JIS-C5201-1 4.23.4	$\leq \pm 0.5\%$ No evidence of mechanical damage						
High Temperature Exposure (Storage)	Put tested resistor in chamber under temperature 2512: $170 \pm 5^\circ\text{C}$ (Others: $150 \pm 5^\circ\text{C}$ ) for 1,000 hours. Then leaving the tested resistor in room temperature for 60 minutes, and measure its resistance variance rate. Refer to JIS-C5201-1 4.23.2	$\leq \pm 1.0\%$ No evidence of mechanical damage						
Temperature Cycling (Rapid Temperature Change)	Put the tested resistor in the chamber under the temperature cycling which shown in the following table shall be repeated 300 times consecutively. Then leaving the tested resistor in the room temperature for 60 minutes, and measure its resistance variance rate. <table border="1" style="margin-left: auto; margin-right: auto;"> <thead> <tr> <th colspan="2">Testing Condition</th> </tr> </thead> <tbody> <tr> <td>Lowest Temperature</td> <td><math>-55 +0/-10^\circ\text{C}</math></td> </tr> <tr> <td>Highest Temperature</td> <td><math>150 +10/-0^\circ\text{C}</math></td> </tr> </tbody> </table> Refer to JIS-C5201-1 4.19	Testing Condition		Lowest Temperature	$-55 +0/-10^\circ\text{C}$	Highest Temperature	$150 +10/-0^\circ\text{C}$	0402、0603、0805、1206 : $\leq \pm 1.0\%$ 2512 : $\leq \pm 0.5\%$  No evidence of mechanical damage
Testing Condition								
Lowest Temperature	$-55 +0/-10^\circ\text{C}$							
Highest Temperature	$150 +10/-0^\circ\text{C}$							
Moisture Resistance (Climatic Sequence)	Put the tested resistor in chamber and subject to 10 cycles of damp heat and without power. Each one of which consists of the steps 1 to 7 (Figure 1). Then leaving the tested resistor in room temperature for 24 hr, and measure its resistance variance rate. Refer to MIL-STD 202 Method 106	$\leq \pm 0.5\%$ No evidence of mechanical damage						
Bias Humidity	Put the tested resistor in chamber under $85 \pm 5^\circ\text{C}$ and 85±5%RH with 10% bias and load the rated voltage for 90 minutes on, 30 minutes off, total 1,000 hours. Then leaving the tested resistor in room temperature for 60 minutes, and measure its resistance variance rate. Refer to JIS-C5201-1 4.24	0402、0603 : $\leq \pm 1.0\%$ 0805、1206、2512 : $\leq \pm 0.5\%$ No evidence of mechanical damage						

Test Item	Conditions of Test	Test Limits										
Whisker Test	◎Test item (Thermal Shock test): <table border="1"> <thead> <tr> <th colspan="2">Testing Condition</th> </tr> </thead> <tbody> <tr> <td>Minimum storage temperature</td> <td>-55+0/-10°C</td> </tr> <tr> <td>Maximum storage temperature</td> <td>85+10/-0°C</td> </tr> <tr> <td>Temperature-retaining time</td> <td>10 min.</td> </tr> <tr> <td>Number of temperature cycles</td> <td>1,500</td> </tr> </tbody> </table>	Testing Condition		Minimum storage temperature	-55+0/-10°C	Maximum storage temperature	85+10/-0°C	Temperature-retaining time	10 min.	Number of temperature cycles	1,500	Max. 50 μm
	Testing Condition											
Minimum storage temperature	-55+0/-10°C											
Maximum storage temperature	85+10/-0°C											
Temperature-retaining time	10 min.											
Number of temperature cycles	1,500											
◎Inspection: Inspect for whisker formation on specimens that underwent the acceleration test specified in subclause 4.2, with a magnifier (stereo microscope) of about 40 or higher magnification. If judgment is hard in this method, use a scanning electron microscope (SEM) of about 1,000 or higher magnification. By JESD Standard NO.22A121 class 2.												

**5.4 Operational Life Endurance:**

Test Item	Conditions of Test	Test Limits
Load Life	Put the tested resistor in chamber under temperature 70±2°C and load the rated voltage for 90 minutes on 30 minutes off, total 1000 hours. Then leaving the tested resistor in room temperature for 60 minutes, and measure its resistance variance rate. Refer to JIS-C5201-1 4.25	0402、0603、0805、1206 : ≤±1.0% 2512 : ≤±2.0%
		No evidence of mechanical damage

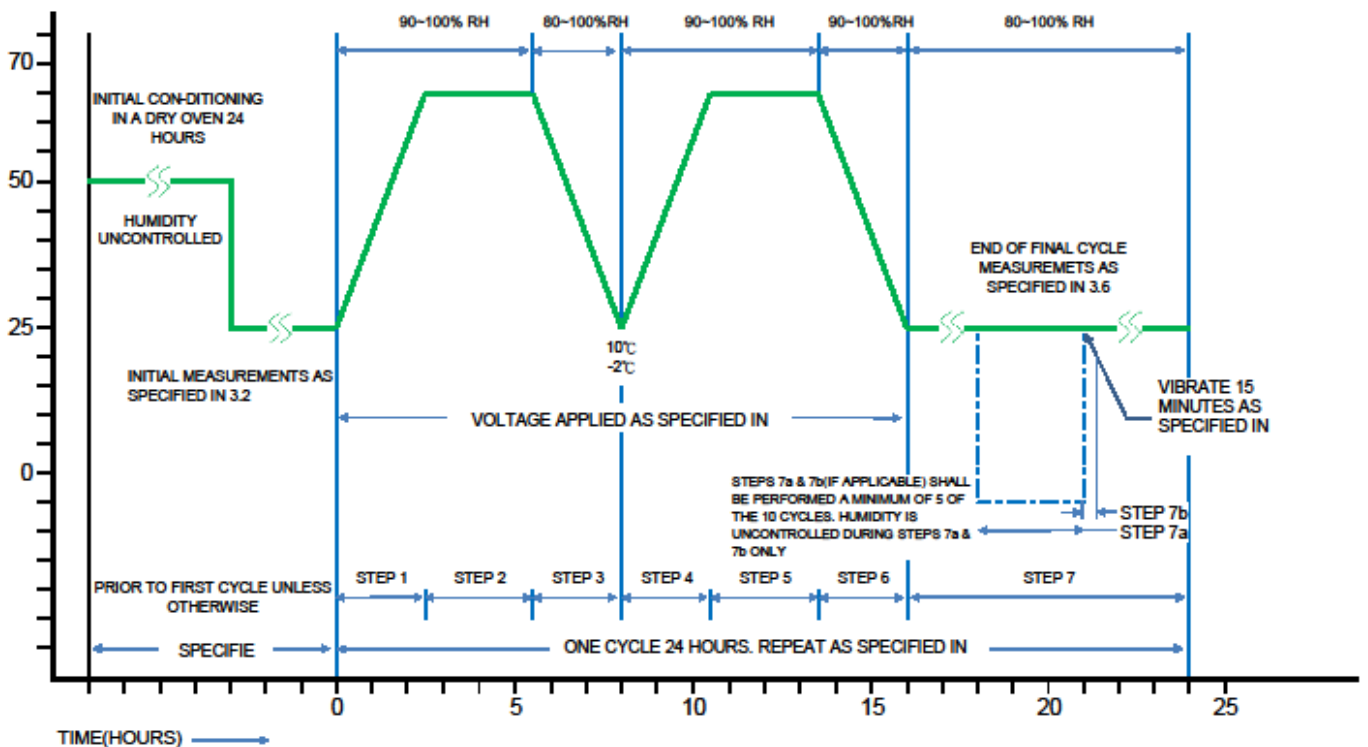

Remark

IT'S NOT UNDER CONTROL FOR PDF FILE  
PLS NOTE THE VERSION STATED..

Issue Dep. DATA Center.

Do not copy without permission

Series No. **60**

**6 Marking Format:**

6.1 Marking Styles by Laser(For LRH0805/LRH1206):

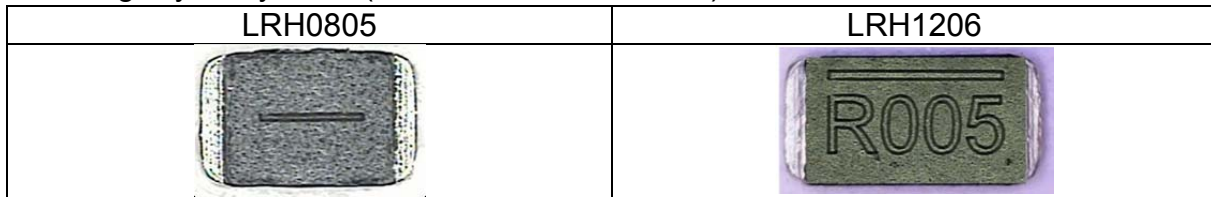

6.2 LRH1206、LRH2512 Series:

Product resistance is indicated by using two marking notation styles:

- a. "R" designates the decimal location in ohms, e.g.
  - For 1mΩ the product marking is R001;
  - For 25mΩ the product marking is R025;
  - For 100mΩ the product marking is R100.
- b. "m" designates the decimal location in milliohms, e.g.
  - For 0.25mΩ the product marking is 0m25;
  - For 0.5mΩ the product marking is 0m50;
  - For 5.5mΩ the product marking is 5m50;
  - For 25.5mΩ the product marking is 25m5.

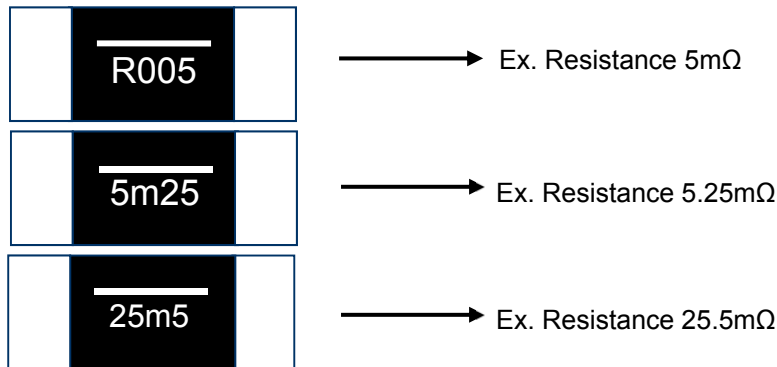

Remark

IT'S NOT UNDER CONTROL FOR PDF FILE  
PLS NOTE THE VERSION STATED..

Issue Dep. DATA Center.

Do not copy without permission

Series No. **60**



**6.3 Marking Styles by Laser(For LRH1206):**

Type	Marking											
	R	m	1	2	3	4	5	6	7	8	9	0
1206												

**6.4 Marking Style(For LRH2512):**

Type	Marking											
	R	m	1	2	3	4	5	6	7	8	9	0
2512												

6.5 LRH0402、LRH0603 No Marking.

**7 Plating Thickness:**

7.1 Ni :  $\geq 2 \mu m$

7.2 Sn(Tin) :  $\geq 3 \mu m$

7.3 Sn(Tin) : Matte Sn

**8 Measurement Point :**

Bottom electrode		Unit : mm	
TYPE	DIM	A	B
		LRH0402	0.65±0.05
LRH0603	1.25±0.05	0.30±0.05	
LRH0805	1.65±0.05	0.70±0.05	
LRH1206	2.70±0.05	0.40±0.05	
LRH2512	5.25±0.25	2.25±0.25	

⊕ Current Terminal  
 ⊖ Voltage Terminal

Remark

IT'S NOT UNDER CONTROL FOR PDF FILE  
PLS NOTE THE VERSION STATED..

Issue Dep. DATA Center.

Do not copy without permission

Series No. **60**

**9 Taping specifications:**

**9.1 Carrier Tape Dimensions:**

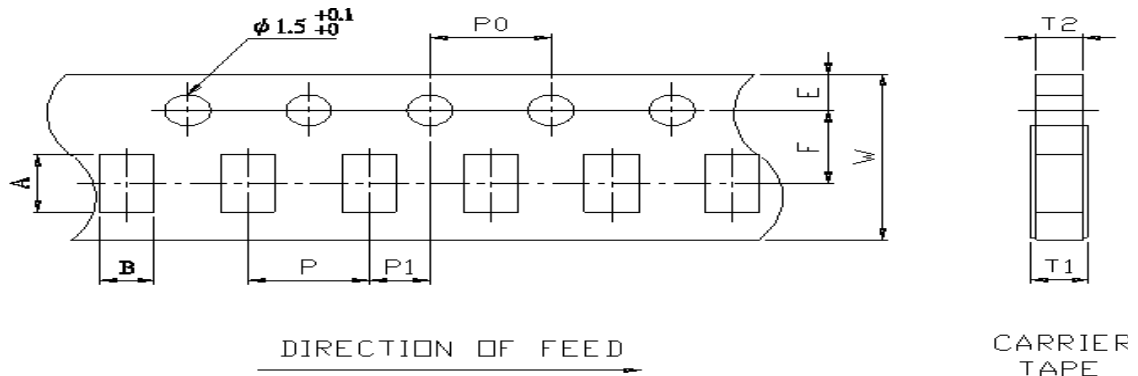

**9.2 Embossed Tape Dimensions:**

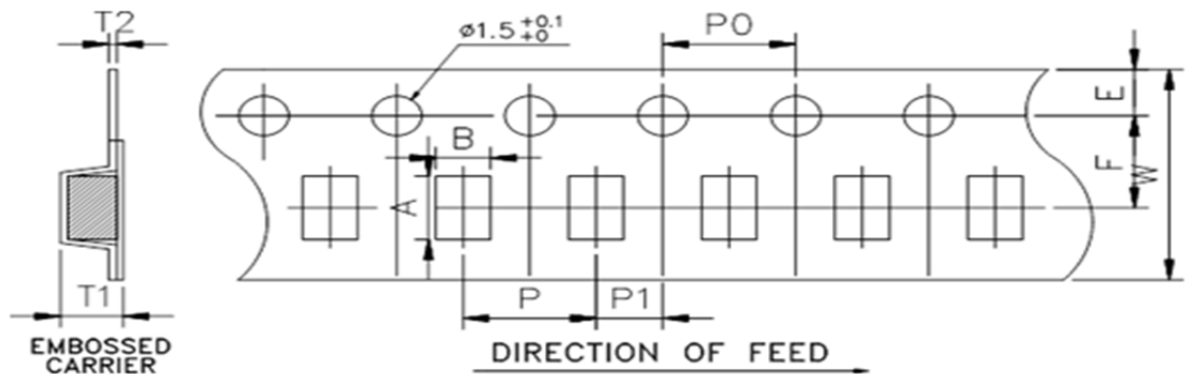

Unit: mm

DIM Item	A	B	W	E	F	T1	T2	P	P0	10*P0	P1
0402	1.15±0.05	0.65±0.05	8.0±0.20	1.75±0.10	3.5±0.05	0.40+0.2/-0	0.40±0.05	2.0±0.10	4.0±0.05	40.0±0.20	2.0±0.05
0603	1.80±0.10	1.00±0.10	8.0±0.20	1.75±0.10	3.5±0.05	0.40+0.2/-0	0.40±0.05	4.0±0.10	4.0±0.10	40.0±0.20	2.0±0.05
0805	2.30±0.10	1.55±0.10	8.0±0.20	1.75±0.10	3.5±0.05	0.40+0.2/-0	0.40±0.05	4.0±0.10	4.0±0.10	40.0±0.20	2.0±0.05
1206	3.50±0.20	1.90±0.20	8.0±0.20	1.75±0.10	3.5±0.05	0.60+0.2/-0	0.60±0.05	4.0±0.10	4.0±0.10	40.0±0.20	2.0±0.05
2512	6.75±0.10	3.50±0.10	12.0±0.15	1.75±0.10	5.5±0.10	1.30±0.10	0.20±0.05	4.0±0.10	4.0±0.10	40.0±0.20	2.0±0.10

Remark

IT'S NOT UNDER CONTROL FOR PDF FILE  
PLS NOTE THE VERSION STATED..

Do not copy without permission

Issue Dep. DATA Center.

Series No. **60**

**9.3 Packaging model:**

Type	Tape width	Max. Packaging Quantity (pcs/reel)		
		Carrier Tape		Embossed Plastic Type
		2mm pitch	4mm pitch	4mm pitch
0402	8mm	10,000pcs	--	--
0603	8mm	--	5,000pcs	--
0805	8mm	--	5,000pcs	--
1206	8mm	--	5,000pcs	--
2512	12mm	--	--	4,000pcs

**9.4 Reel Dimensions:**

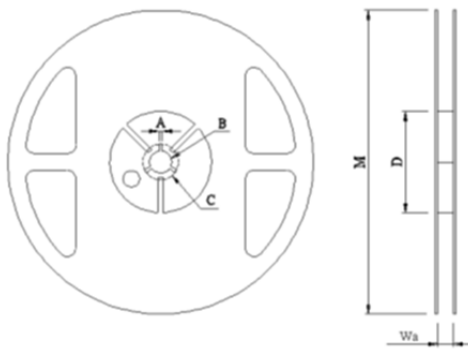

Unit: mm

Item	Reel Type / Tape	Wa	M	A	B	C	D
0402	7" reel for 8 mm tape	9.0±0.5	178±2.0	2.0±0.5	13.5±0.5	21.0±0.5	60.0±1.0
0603	7" reel for 8 mm tape	9.0±0.5	178±2.0	2.0±0.5	13.5±0.5	21.0±0.5	60.0±1.0
0805 1206	7" reel for 8 mm tape	9.0±0.5	178±2.0	2.0±0.5	13.5±0.5	21.0±0.5	60.0±1.0
2512	7" reel for 12 mm tape	13.8±0.5	178±2.0	2.0±0.5	13.5±0.5	21.0±0.5	60.0±1.0

**Remark**

IT'S NOT UNDER CONTROL FOR PDF FILE  
PLS NOTE THE VERSION STATED..

Issue Dep.**DATA Center.**

Do not copy without permission

Series No. **60**

**10 Technical application notes: (This is for recommendation, please customer perform adjustment according to actual application)**

**10.1 Recommend soldering method:**

10.1.1 This product is applicable to IR-reflow process only.(Infrared Reflow)

Typical examples of soldering processes that provides reliable joints without any damage are given in below:

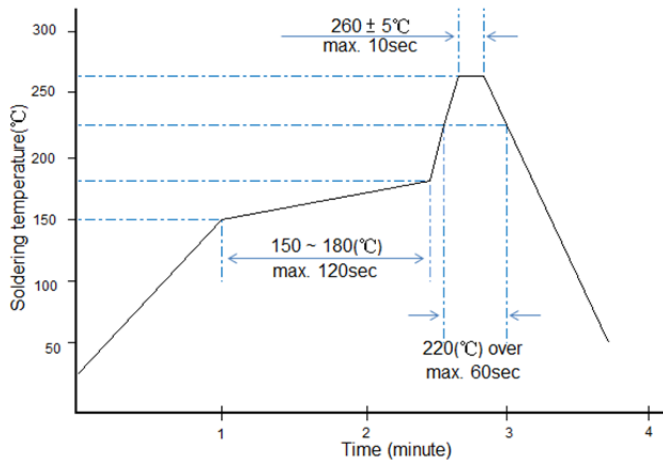

Recommended IR Reflow Soldering Profile  
MEET J-STD-020D

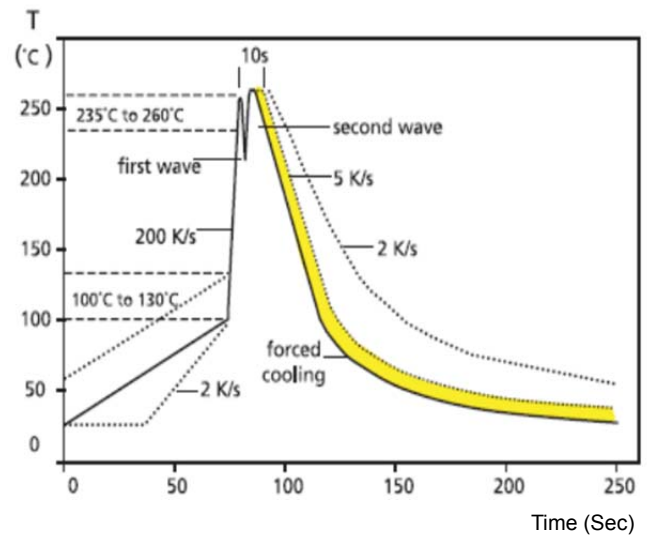

Recommended double-wave Soldering Profile  
Typical values (solid line)  
Process limits (dotted line)

10.1.2 Soldering Iron: temperature 350°C±10°C , dwell time shall be less than 3 sec.

Remark

IT'S NOT UNDER CONTROL FOR PDF FILE  
PLS NOTE THE VERSION STATED..

Issue Dep.**DATA Center.**

Do not copy without permission

Series No. **60**

**10.2 Recommend Land Pattern:**

When a component is soldered, the resistance after soldering changes slightly depending on the size of the soldering area and the amount of soldering. When designing a circuit, it is necessary to consider the effect of a decrease or increase in its resistance.

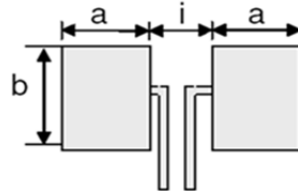

Type	Power Rating (Watts)	Resistance Range (mΩ)	Dimensions - in millimeters		
			a	b	i
0402	0.20	1.5	0.65	0.50	0.50
		$3 \leq R \leq 4$			
		5			
		10			
0603	0.33	1 ~ 24	1.00	1.27	0.50
0805	0.50	1~19	1.45	1.78	0.66
1206	0.50 1.00	$1 \leq R < 3$	1.65	2.18	0.60
		$3 \leq R < 4$	1.65	2.18	0.90
		$4 \leq R \leq 21$	1.65	2.18	1.00
2512	1.50	3~100	2.11	3.68	3.18
	2.00	3 ~ 70			
	3.00	3 ~ 10			

Remark

IT'S NOT UNDER CONTROL FOR PDF FILE  
PLS NOTE THE VERSION STATED..

Issue Dep.**DATA Center.**

Do not copy without permission

Series No. **60**

10.3 Recommend dispensing method (for LRH2512)

10.3.1 The structure of RALEC metal alloy resistor that both side of main body would be thinner due to process factor (as the photo below).

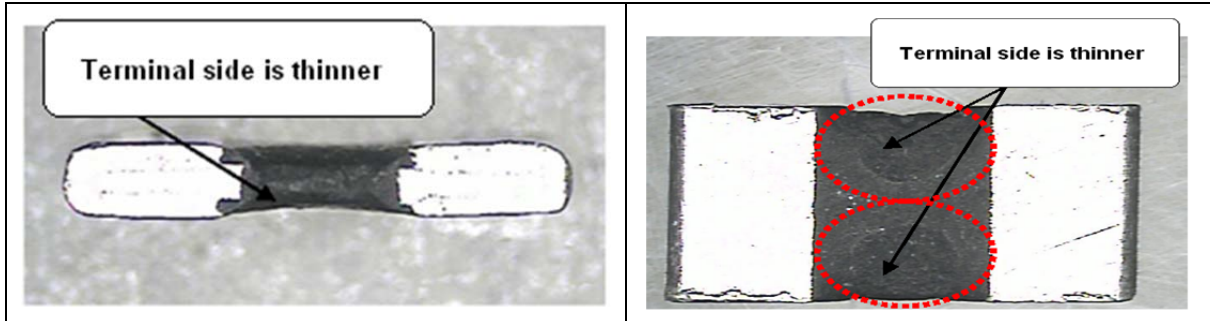

10.3.2 When customer performs wave solder process shall take note on the dispensing gap.

If the gap between two dispensing is over, the red-glue will not adhesive the resistor body and be dropped out (as photo 1). Therefore, we suggest customer to narrow down the dispenser gap (as photo 2), or dispenser on the body center (as photo 3)

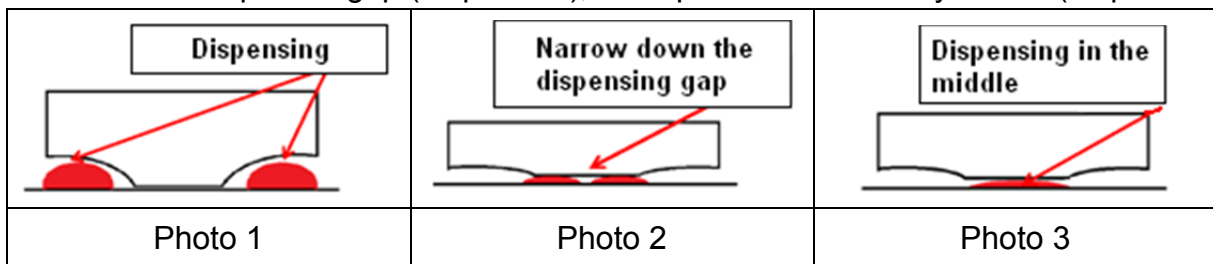

10.4 Product warranted solder area

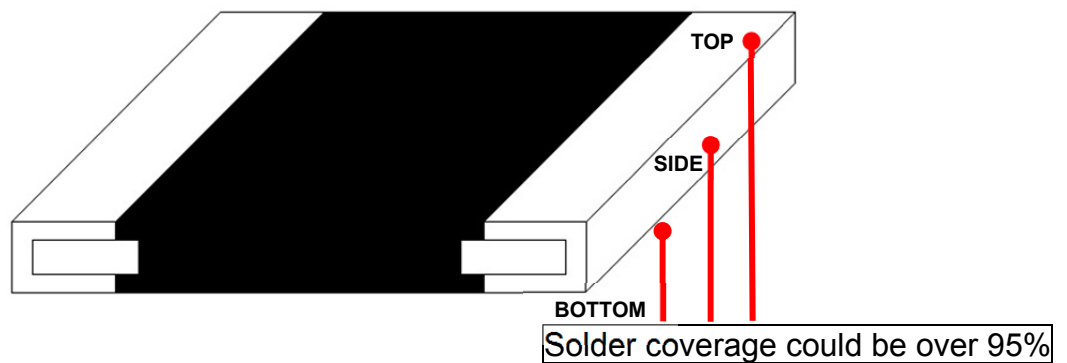

Remark

IT'S NOT UNDER CONTROL FOR PDF FILE  
PLS NOTE THE VERSION STATED..

Issue Dep. **DATA Center.**

Do not copy without permission

Series No. **60**

<b>RALEC</b> 旺詮	<b>LRH Series Metal Alloy Low-Resistance Resistor Product Specifications</b>	<b>Document No.</b>	<b>IE-SP-089</b>
		<b>Released Date</b>	<b>2021/01/01</b>
		<b>Page No.</b>	<b>15</b>

10.5 Environment Precautions:

This specification product is for general electronic use, RALEC will not be responsible for any damage, cost or loss caused by using this specification product in any special environment. If other applications need to confirm with RALEC.

If consumer intends to use our Company product in special environment or condition (including but not limited to those mentioned below), then will need to make individual recognition of product features and reliability accordingly.

- (a) Used in high temperature and humidity environment
- (b) Exposed to sea breeze or other corrosive gas, such as Cl<sub>2</sub>、H<sub>2</sub>S、NH<sub>3</sub>、SO<sub>2</sub> and NO<sub>2</sub>.
- (c) Used in non-verified liquids including water, oil, chemical and organic solvents.
- (d) Using non-verified resin or other coating material to seal or coat our Company product.
- (e) After soldering, it is necessary to use water-soluble detergents to clean residual solder fluxes, even though no-clean fluxes are recommended.

10.6 Momentary Overload Precautions:

The product might be out of function when momentary overloaded. Please make sure to avoid momentary overloading while using and preserving.

10.7 Operation and Processing Precautions:

- (a) Avoid damage to the edge of resistor and protective layer caused by mechanical stress.
- (b) Handle with care when printing circuit board (PCB) is divided or fixed on support body, because bending of printing circuit board (PCB) mounting will make mechanical stress for resistors.
- (c) Make sure the power rating is under the limit when using the resistor. When power rating is over the limit, the resistor will be overloaded. There might be machinery damage due to the climbing temperature.
- (d) If the resistor will be exposed under massive impact load (shock wave) in a short period of time, the working environment must be set up well before use.
- (e) Please make evaluation and confirmation when the product is well used in your company and have a through consideration of it's fail-safe design to ensure the system safety.

<b>Remark</b>	IT'S NOT UNDER CONTROL FOR PDF FILE PLS NOTE THE VERSION STATED..	Issue Dep. <b>DATA Center.</b>
	Do not copy without permission	Series No. <b>60</b>

<b>RALEC</b> 旺詮	<b>LRH Series Metal Alloy Low-Resistance Resistor Product Specifications</b>	<b>Document No.</b>	<b>IE-SP-089</b>
		<b>Released Date</b>	<b>2021/01/01</b>
		<b>Page No.</b>	<b>16</b>

**11 Storage and transportation requirement:**

- 11.1 The temperature condition must be controlled at 25±5°C, the R.H. must be controlled at 60±15%. The stock can maintain quality level in two years .
- 11.2 Please avoid the mentioned harsh environment below when storing to ensure product performance and its' weldability. Places exposed to sea breeze or other corrosive gas, such as Cl2、H2S、NH3、SO2 and NO2.
- 11.3 When the product is moved and stored, please ensure the correct orientation of the box. Do not drop or squeeze the box. Otherwise, the electrode or the body of the product may be damaged.

**12 Inductance**

Inductance characteristics: <5nH(Circuit frequency is below 1MHz)

**13 Stock period:**

The temperature condition must be controlled at 25±5°C, the R.H. must be controlled at 60±15%. The stock can maintain quality level in two years.

**14 Attachments**

- 14.1 Document Revise Record (QA-QR-027)

<b>Remark</b>	<div style="border: 1px solid black; padding: 5px; width: fit-content; margin: 0 auto;"> IT'S NOT UNDER CONTROL FOR PDF FILE  PLS NOTE THE VERSION STATED.. </div>	Issue Dep. <b>DATA Center.</b>
	Do not copy without permission	



<b>RALEC</b> 旺詮	<b>LRH Series Metal Alloy Low-Resistance Resistor Product Specifications</b>	<b>Document No.</b>	<b>IE-SP-089</b>
		<b>Released Date</b>	<b>2021/01/01</b>
		<b>Page No.</b>	<b>17</b>

**Legal disclaimer**

RALEC, its distributors and agents (collectively, "RALEC"), hereby disclaims any and all liabilities for any errors, inaccuracies or incompleteness contained in any product related information, including but not limited to product specifications, datasheets, pictures and/or graphics. RALEC may make changes, modifications and/or improvements to product related information at any time and without notice.

RALEC makes no representation, warranty, and/or guarantee about the fitness of its products for any particular purpose or the continuing production of any of its products. To the maximum extent permitted by law, RALEC disclaims (i) any and all liability arising out of the application or use of any RALEC product, (ii) any and all liability, including without limitation special, consequential or incidental damages, and (iii) any and all implied warranties, including warranties of fitness for a particular purpose, non-infringement and merchantability.

RALEC defined this product is for general electrical use , not design for any application for automotive electrical ,life-saving or life support equipment, or any application which may inflict casualties if RALEC product failure occurred. When consumer is using or selling products of RALEC without having discussion with the sales representatives and specifically stated the applicability mentioned above in a written form, then the client need to take a full responsibility and agree to protect RALEC from punishment and damage.

Information provided here is intended to indicate product specifications only. RALEC reserves all the rights for revising this content without further notification, as long as products are unchanged. Any product change will be announced by ECN.

<b>Remark</b>	IT'S NOT UNDER CONTROL FOR PDF FILE PLS NOTE THE VERSION STATED..	Issue Dep. <b>DATA Center.</b>
	Do not copy without permission	Series No. <b>60</b>