

Power Inductor APSR Series

**Automotive
AEC-Q200**

RoHS Compliant
Halogen Free
REACH Compliant

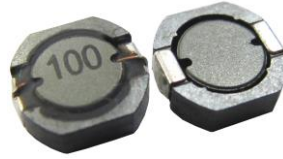

Power
Circuit

Shield

Wire
Wound

Ferrite

Part Numbering

A	PSR	00	080725	1R0	M	00
Grade	Series Name	Control Code	Dimensions Code (mm)	Inductance (μ H)	Tolerance	Internal Code
			050522 5.2x5.0x2.2	R47 0.47	M \pm 20%	
			080725 7.5x7.4x2.5	1R0 1.0	T \pm 30%	
			080740 7.5x7.4x4.0	101 100		

Power Inductor APSR Series

**Automotive
AEC-Q200**

APSR00050522 Type

■ Dimensions

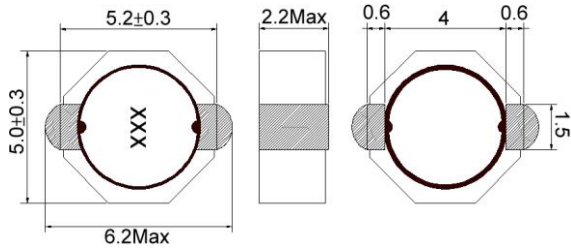

unit:mm

■ Recommended Land Pattern

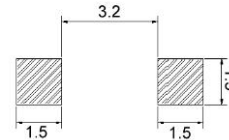

unit:mm

■ Electrical Characteristics

Part No.	Inductance (uH)	Test Freq.	RDC (mΩ)Max.	Isat (A)	Irms (A)	Tolerance (±%)	Marking
APSR000505221R2□00	1.2	100kHz,1V	25	4.3	3.43	30	1R2
APSR000505221R8□00	1.8	100kHz,1V	32	3.6	3.12	30	1R8
APSR000505223R3□00	3.3	100kHz,1V	54	2.5	2.68	30	3R3
APSR000505224R7□00	4.7	100kHz,1V	81	2.0	2.18	30	4R7
APSR0005052210□00	10	100kHz,1V	160	1.4	1.51	20,30	100
APSR00050522220□00	22	100kHz,1V	320	0.9	1.02	20,30	220
APSR00050522330□00	33	100kHz,1V	490	0.77	0.80	20,30	330

Note: When ordering, please specify tolerance code. Tolerance: M=±20% / T=±30%

1. Operating temperature range - 40°C ~ 125°C(Including self - temperature rise)
2. Isat for Inductance drop 35% from its value without current
3. Irms for a 40°C temprature rise from 25°C ambient with current
4. Measure Equipment:
 L: Agilent E4980 or HP4284A
 RDC: Chroma 16502
 Isat: HP4284A+HP42841A or WK3260B+WK3265B
 Irms: Agilent 6641 SYSTEM DC POWER SUPPLY

APSR00050522 Type

■ Characteristics Graph

Inductance vs. Frequency Characteristics

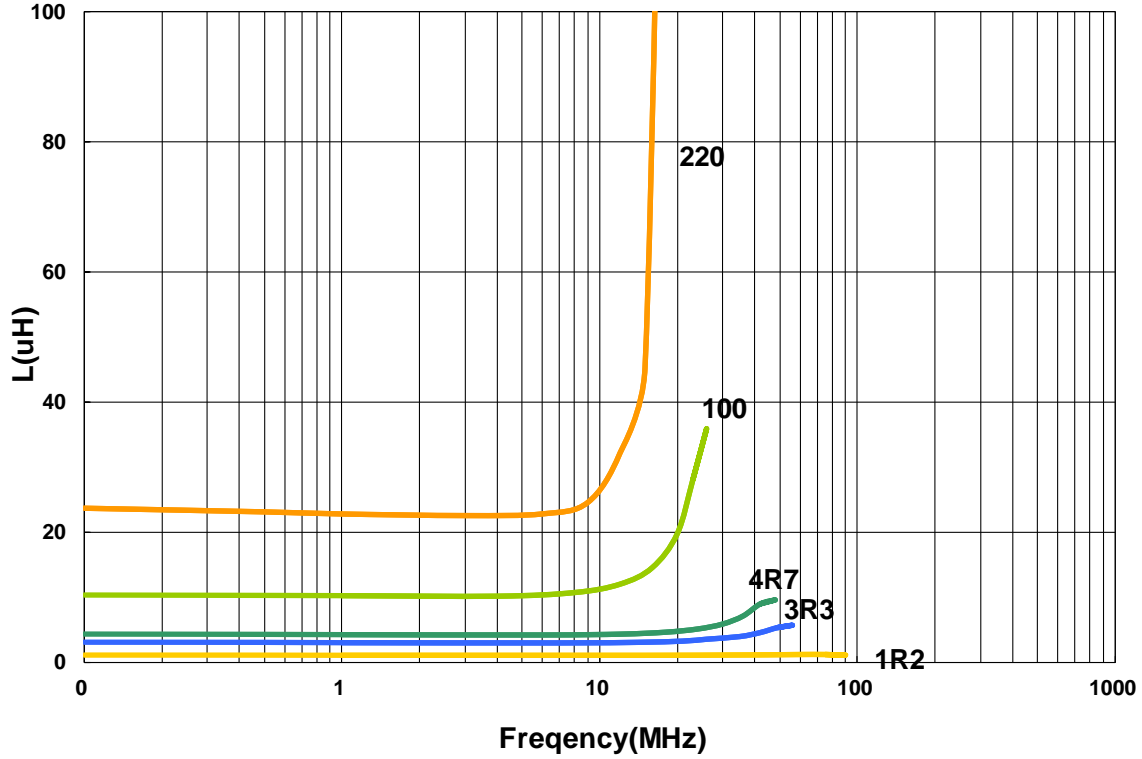

Inductance vs. DC Current

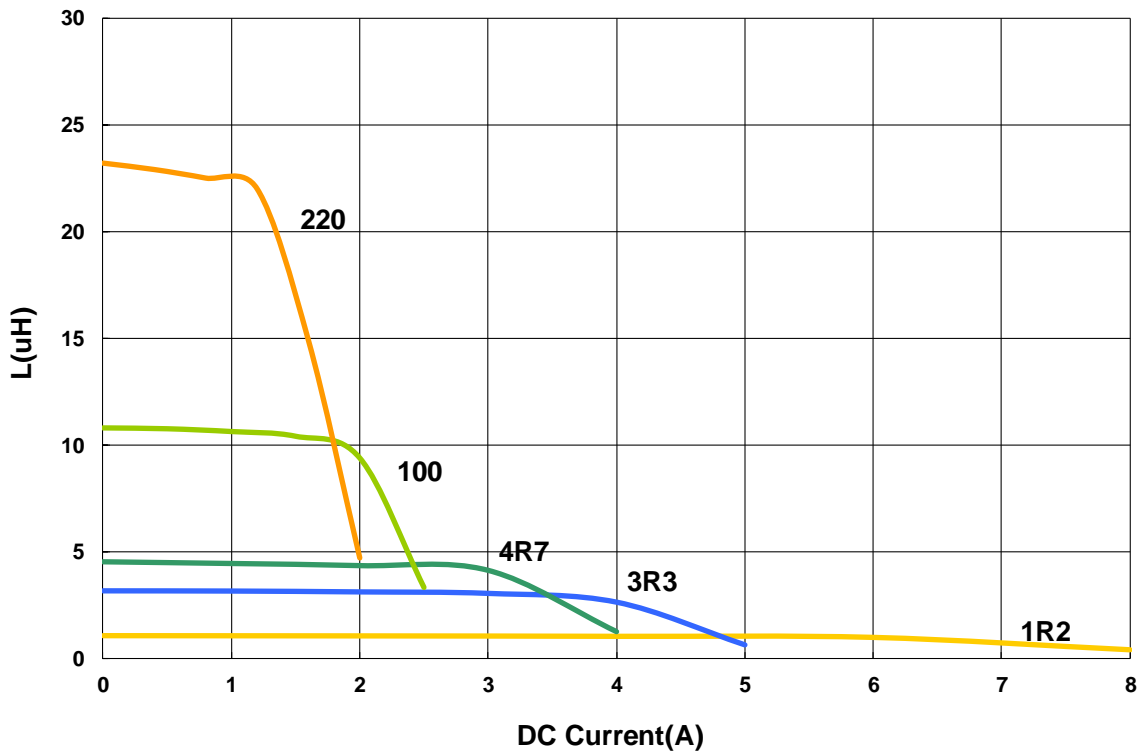

Power Inductor APSR Series

**Automotive
AEC-Q200**

APSR00080725 Type

■ Dimensions

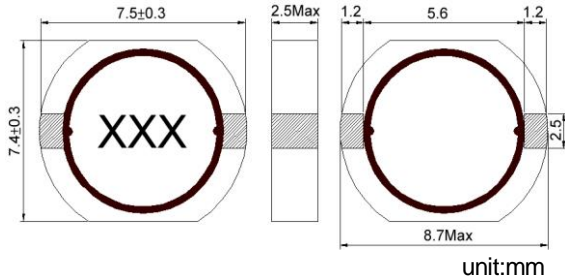

unit:mm

■ Recommended Land Pattern

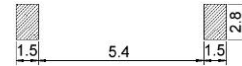

unit:mm

■ Electrical Characteristics

Part No.	Inductance (uH)	Test Freq.	RDC (mΩ)Max.	Isat (A)	Irms (A)	Tolerance (±%)	Marking
APSR000807251R0□00	1.0	100kHz,1V	14.28	2.20	6.22	30	1R0
APSR000807251R5□00	1.5	100kHz,1V	19.70	2.08	5.00	30	1R5
APSR000807252R2□00	2.2	100kHz,1V	24.09	1.86	4.40	30	2R2
APSR000807253R3□00	3.3	100kHz,1V	41.2	1.80	3.70	30	3R3
APSR000807254R7□00	4.7	100kHz,1V	49.7	1.80	3.20	30	4R7
APSR000807255R6□00	5.6	100kHz,1V	58.9	1.39	2.90	20,30	5R6
APSR000807256R8□00	6.8	100kHz,1V	66.3	1.32	2.70	20,30	6R8
APSR00080725100□00	10	100kHz,1V	92.4	1.25	1.90	20,30	100
APSR00080725150□00	15	100kHz,1V	170	1.20	1.70	20,30	150
APSR00080725220□00	22	100kHz,1V	210	1.13	1.52	20,30	220
APSR00080725330□00	33	100kHz,1V	320	0.91	1.10	20,30	330
APSR00080725470□00	47	100kHz,1V	490	0.85	0.95	20,30	470

Note: When ordering, please specify tolerance code. Tolerance: M=±20% / T=±30%

1. Operating temperature range - 40°C ~ 125°C(Including self - temperature rise)
2. Isat for Inductance drop 35% from its value without current
3. Iirms for a 40°C temprature rise from 25°C ambient with current
4. Measure Equipment:
 L: Agilent E4980 or HP4284A
 RDC: Chroma 16502
 Isat: HP4284A+HP42841A or WK3260B+WK3265B
 Iirms: Agilent 6641 SYSTEM DC POWER SUPPLY

APSR00080725 Type

■ Characteristics Graph

Inductance vs. Frequency Characteristics

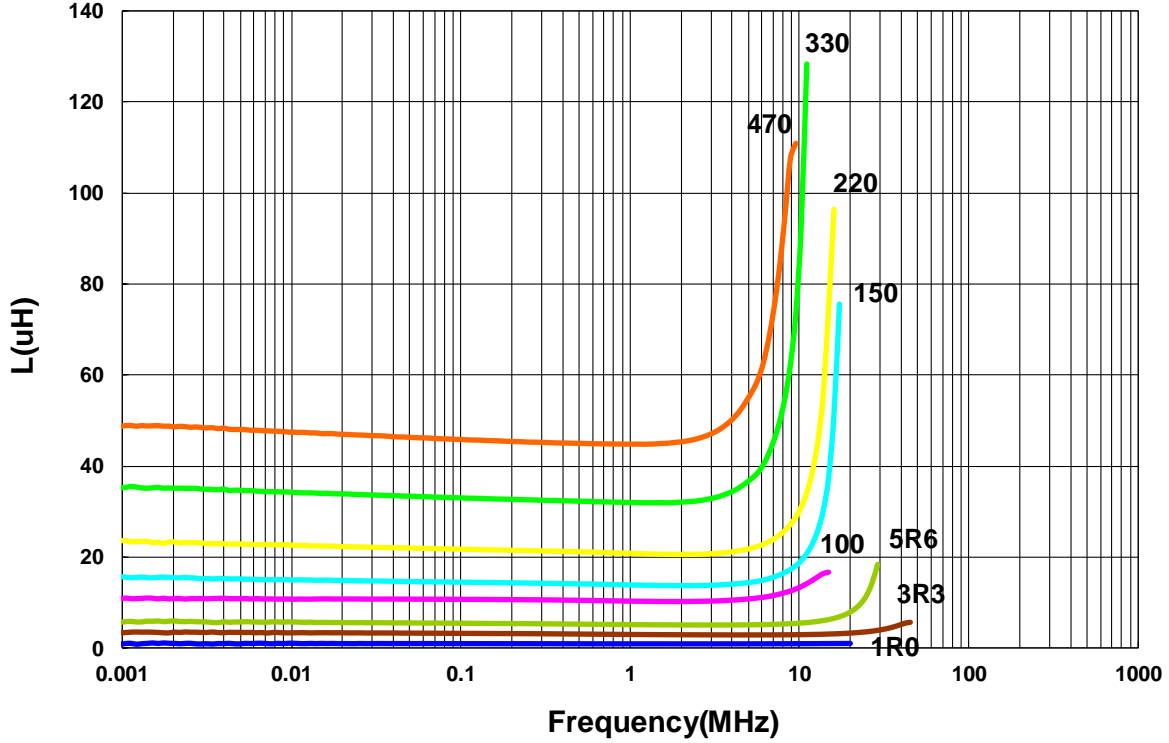

Inductance vs. DC Current

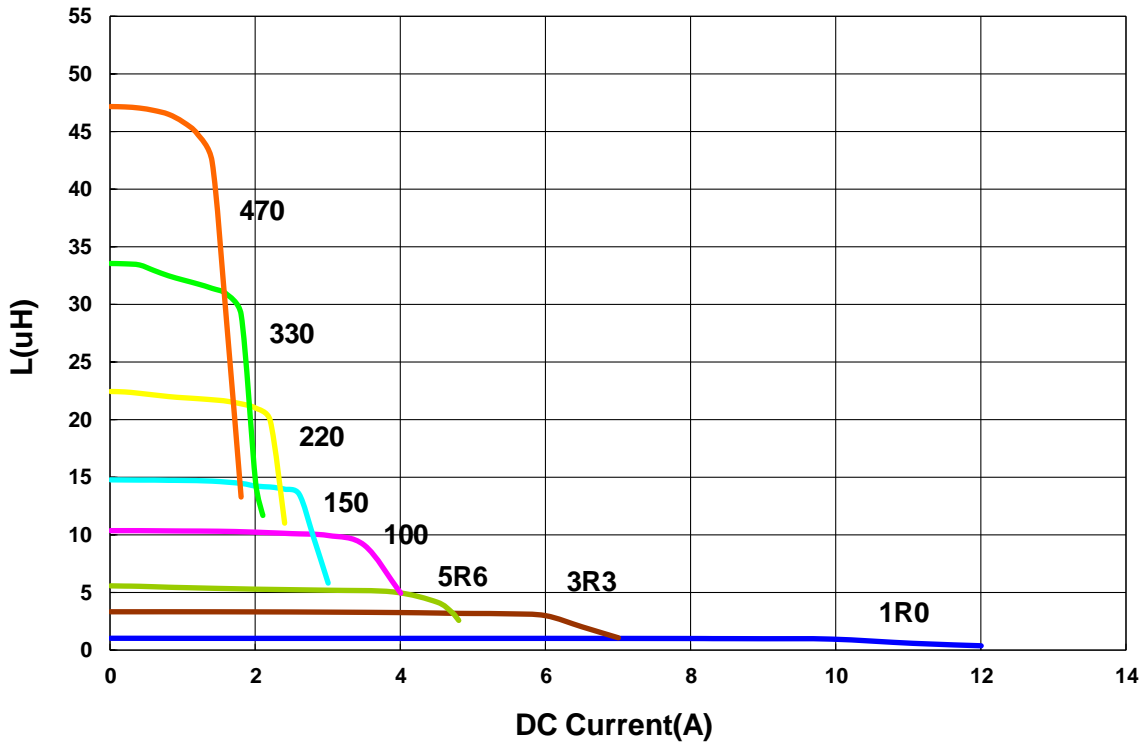

Power Inductor APSR Series

**Automotive
AEC-Q200**

APSR00080740 Type

■ Dimensions

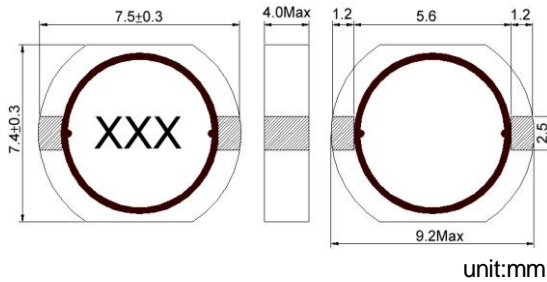

unit:mm

■ Recommended Land Pattern

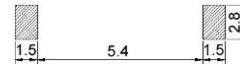

unit:mm

■ Electrical Characteristics

Part No.	Inductance (uH)	Test Freq.	RDC (mΩ)Max.	Isat(A) Max(Typ)	Irms (A)	Tolerance (±%)	Marking
APSR000807401R0□00	1.0	100kHz,1V	6.38	8.0(12)	9.00	30	1R0
APSR000807401R5□00	1.5	100kHz,1V	8.64	7.0(10)	8.00	30	1R5
APSR000807401R8□00	1.8	100kHz,1V	9.60	6.5(8.6)	7.92	30	1R8
APSR000807402R5□00	2.5	100kHz,1V	13.6	4.8(7.2)	7.40	30	2R5
APSR000807403R3□00	3.3	100kHz,1V	17.8	3.9(6.8)	6.70	30	3R3
APSR000807404R7□00	4.7	100kHz,1V	26.6	3.5(4.6)	4.90	20,30	4R7
APSR000807405R6□00	5.6	100kHz,1V	29.0	3.3(4.1)	4.60	20,30	5R6
APSR000807406R8□00	6.8	100kHz,1V	34.0	3.2(3.9)	3.90	20,30	6R8
APSR00080740100□00	10	100kHz,1V	55.6	2.5(3.4)	3.25	20,30	100
APSR00080740150□00	15	100kHz,1V	71.4	2.1(3.0)	2.70	20,30	150
APSR00080740220□00	22	100kHz,1V	98.1	1.7(2.4)	2.40	20,30	220
APSR00080740330□00	33	100kHz,1V	140	1.4(2.0)	1.90	20,30	330
APSR00080740470□00	47	100kHz,1V	217	1.2(1.7)	1.48	20,30	470
APSR00080740560□00	56	100kHz,1V	260	1.0(1.5)	1.33	20,30	560
APSR00080740680□00	68	100kHz,1V	310	0.95(1.36)	1.20	20,30	680
APSR00080740820□00	82	100kHz,1V	360	0.9(1.20)	1.12	20,30	820
APSR00080740101□00	100	100kHz,1V	480	0.85(1.12)	0.95	20,30	101
APSR00080740121□00	120	100kHz,1V	560	0.75(1.00)	0.89	20,30	121
APSR00080740151□00	150	100kHz,1V	710	0.65(0.92)	0.82	20,30	151

Note: When ordering, please specify tolerance code. Tolerance: M=±20% / T=±30%

1. Operating temperature range - 40°C ~ 125°C(Including self - temperature rise)
2. Isat for Inductance drop 35% from its value without current
3. Iirms for a 40°C temperature rise from 25°C ambient with current
4. Measure Equipment:
 - L: Agilent E4980 or HP4284A
 - RDC: Chroma 16502
 - Isat: HP4284A+HP42841A or WK3260B+WK3265B
 - Iirms: Agilent 6641 SYSTEM DC POWER SUPPLY

APSR00080740 Type

■ Characteristics Graph

Inductance vs. Frequency Characteristics

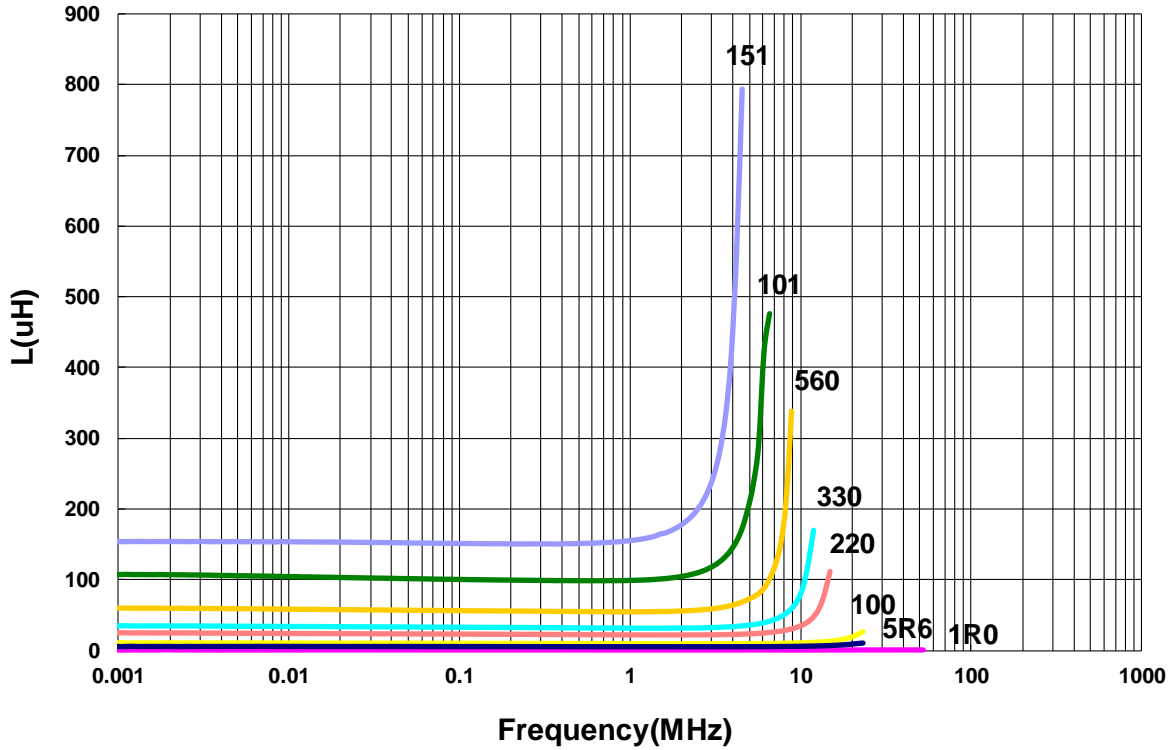

Inductance vs. DC Current

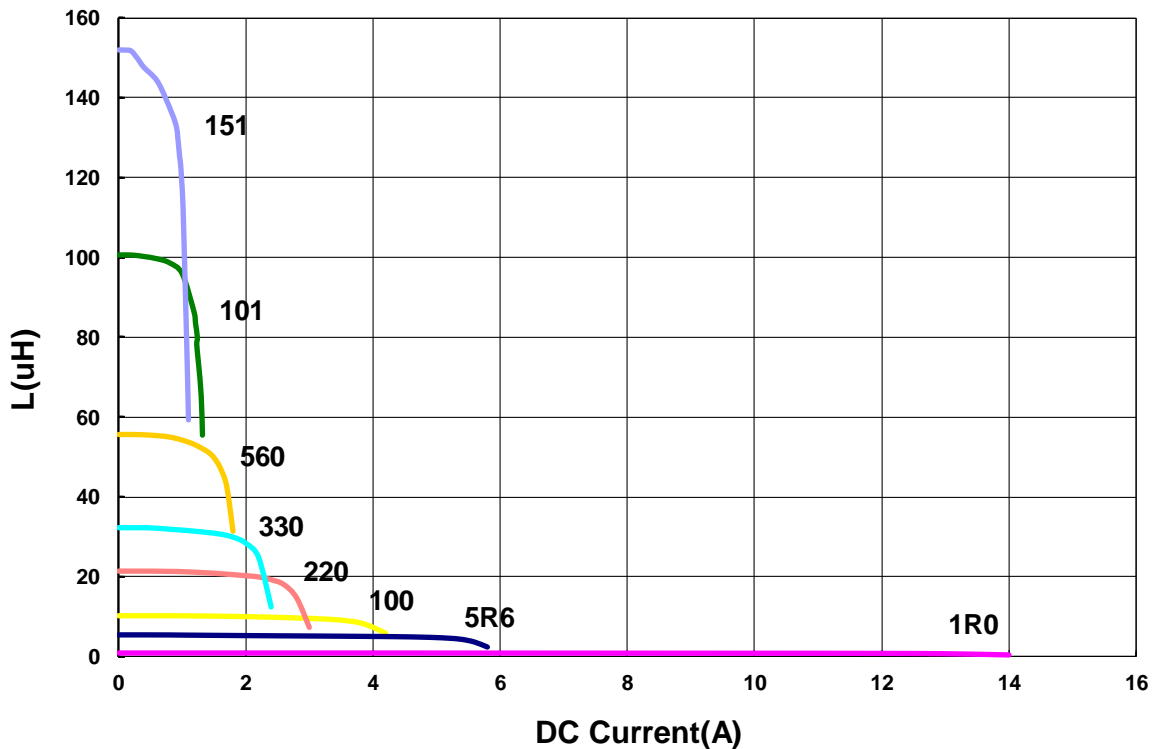

Power Inductor APSR Series

**Automotive
AEC-Q200**

■ Packaging

Tape Dimensions

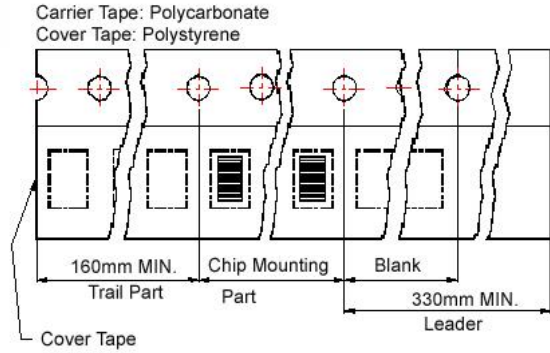
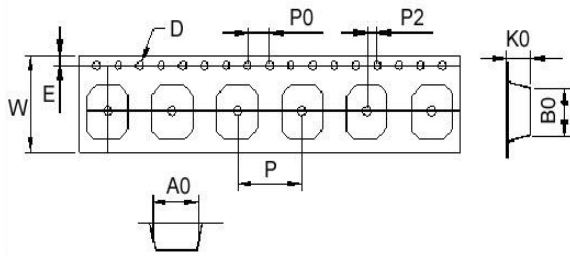

Reel Dimensions

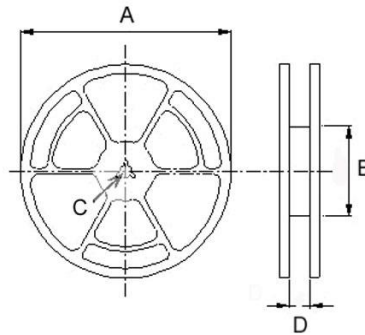

Dimensions in mm

TYPE										Reel Dimensions				Quantity
	A0	B0	K0	D	E	W	P	P0	P2	A	B	C	D	PCS / REEL
APSR00050522	5.25	6.25	2.4	1.55	1.75	12	8	4	2	330	100	13	13.4	2000
APSR00080725	7.60	8.65	2.8	1.55	1.75	16	12	4	2	330	100	13	16	1500
APSR00080740	7.60	9.00	4.3	1.55	1.75	16	12	4	2	330	100	13	16	1000