

BPSP Series

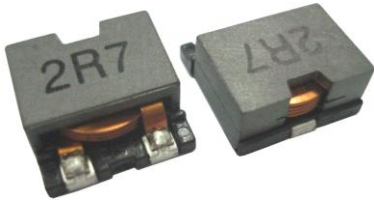

AEC-Q200 Grade 1 qualified, Designed for high current power supply applications, Flat wire windings provide exceptionally low DCR

Features

- High current carrying capacity
- Flat wire windings provide exceptionally low DCR
- Three mounting pins for additional stability in high-vibration

Applications

- High current, low voltage power supply applications
- Audio boost circuit

Product Identification

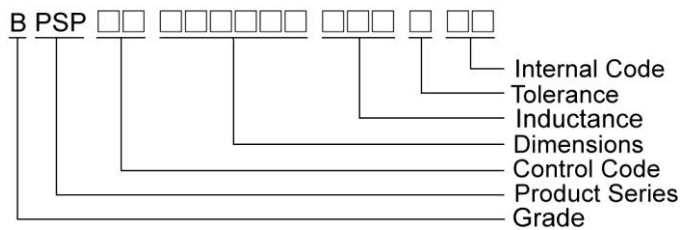

Shape and Dimensions

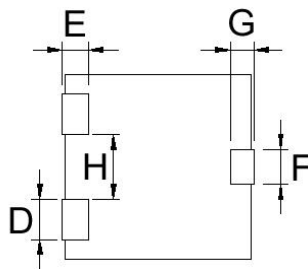
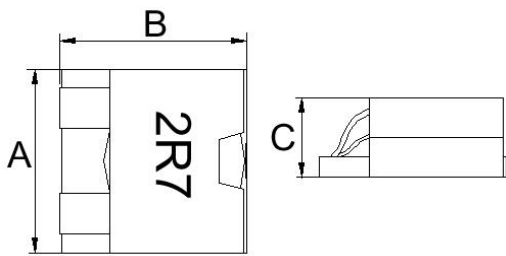

Recommended Pattern

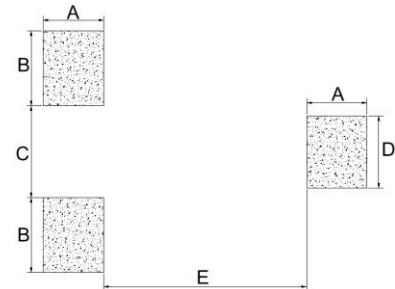

Dimensions in mm

TYPE	Shape and Dimensions								Recommended Pattern				
	A±0.3	B±0.3	C±0.35	D±0.2	E±0.2	F±0.2	G±0.2	H±0.2	A	B	C	D	E
BPSP00131355	12.6	12.7	5.45	2.6	2.0	2.5	1.6	4.3	2.5	3.1	3.8	3.0	8.4

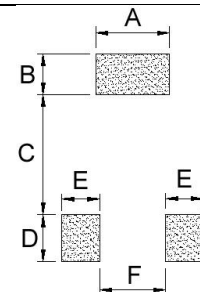
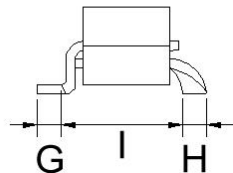
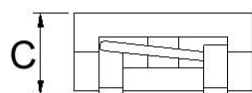
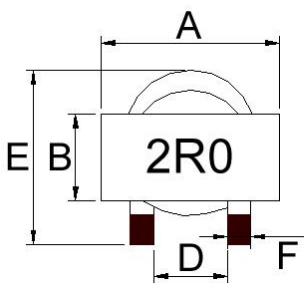

Dimensions in mm

TYPE	Shape and Dimensions									Recommended Pattern					
	A±0.5	B±0.5	C Max	D±0.5	E±0.86	F±0.2	G±0.5	H±0.2	I±0.5	A	B	C	D	E	F
BPSP00190911	19	9	10.67	7.9	18.7	2.54	3.18	2.54	13.08	7.37	4.06	11.94	4.7	3.81	6.6

SMD Shielded Power Inductors – BPSP Series

Electrical Characteristics

Part Number	Inductance (μH)	Tolerance ($\pm\%$)	Test Frequency (kHz)	SRF (MHz) Typ.	RDC (m Ω) Max	Isat 1	Isat 2	Isat 3	Irms 1 (A)	Irms 2 (A)	Marking
						(A) Max(Typ)	(A) Max(Typ)	(A) Max(Typ)			
BPSP001313551R0K00	1.0	10	100	75	2.6	25(32)	26(33)	27(33.5)	9.5	13	1R0
BPSP001313551R8K00	1.8	10	100	50	2.6	14(17)	16(19)	16.5(20)	9.5	13	1R8
BPSP001313552R7K00	2.7	10	100	42	2.6	9(12)	10(13)	11(14)	10	13.5	2R7

Note: When ordering, please specify tolerance code. Tolerance: T=±30%

- Operating temperature range - 40°C ~ 125°C(Including self - temperature rise)
- Isat 1 for Inductance drop 10%
- Isat 2 for Inductance drop 20%
- Isat 3 for Inductance drop 30%
- Irms 1 for a 20°C temperature rise from 25°C ambient with current
- Irms 2 for a 40°C temperature rise from 25°C ambient with current
- Measure Equipment :
L : WK3260B+WK3265B , 100kHz/ 0.1V
RDC : Chroma 16502
Isat : WK3260B+WK3265B

Test Instruments : HP4294A Impedance / Material Analyzer

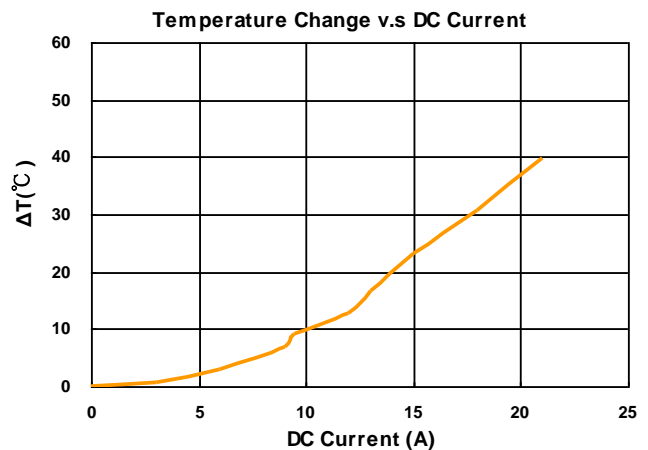
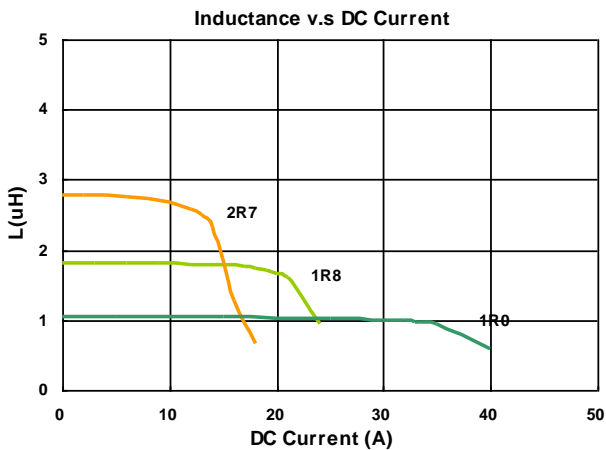

SMD Shielded Power Inductors – BPSP Series

Electrical Characteristics

Part Number	Inductance (μ H)	Tolerance (\pm %)	Test Frequency (kHz)	SRF (MHz)Min.	RDC (m Ω)Max	Isat (A)Max	Irms 1 (A)Max	Irms 2 (A)Max	Marking
BPSP001909112R0M00	2.0	20	100	39	1.4	34.4	30	40	2R0

Note: When ordering, please specify tolerance code. Tolerance: M= \pm 20%

- Operating temperature range - 40°C ~ 125°C(Including self - temperature rise)
- Isat for Inductance drop 10%
- Irms 1 for a 20°C temperature rise from 25°C ambient with current
- Irms 2 for a 40°C temperature rise from 25°C ambient with current
- Measure Equipment :
 - L : WK3260B+WK3265B , 100kHz/ 0.1V
 - RDC : Chroma 16502
 - Isat : WK3260B+WK3265B

Test Instruments : HP4294A Impedance / Material Analyzer

Packaging Specifications

Tape Dimensions

Tape Material

Figure 1

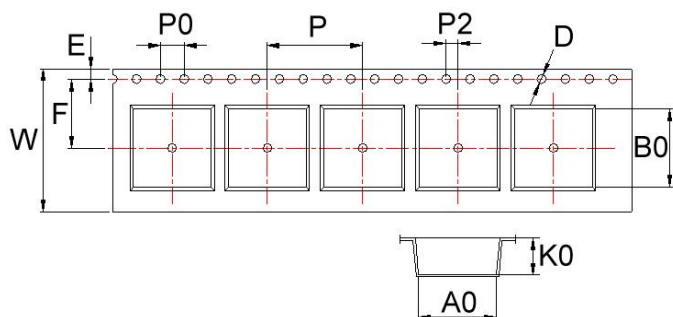

Carrier Tape: Polycarbonate
Cover Tape: Polystyrene

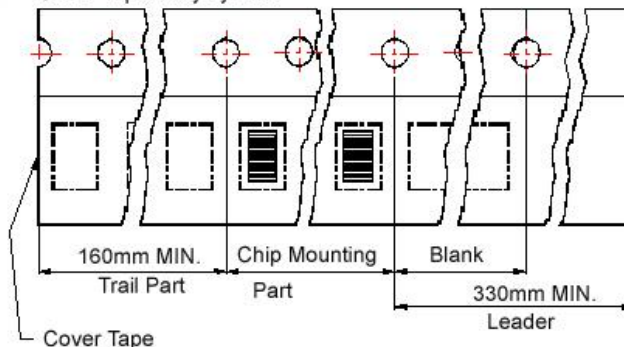
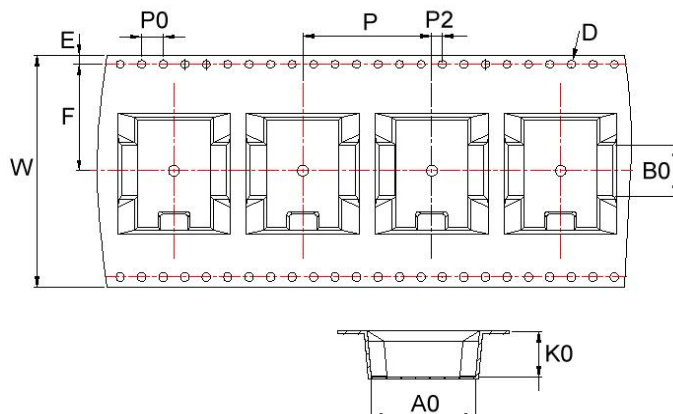
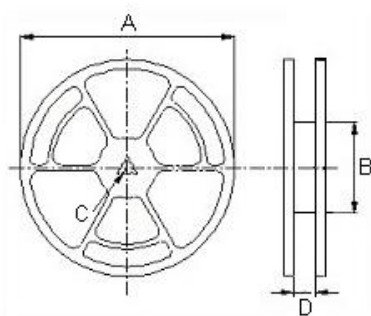

Figure 2



Reel Dimensions



Dimensions in mm

TYPE	Fig	Tape Dimensions										Reel Dimensions				Quantity
		A0	B0	K0	D	E	F	W	P	P0	P2	A	B	C	D	PCS / REEL
BPSP00131355	1	13.1	13.2	6.4	1.55	1.75	11.5	24	16	4	2	330	100	13	24.4	500
BPSP00190911	2	19.5	9.6	8.5	1.55	1.75	20.2	44	24	4	2	330	100	13	44.9	200